



# SANCTUARY 5000

---

OWNER'S MANUAL

---





**PRODUCT INFORMATION**

Functions & Settings.....4  
 Parts.....8  
 Diagram.....9  
 Product Information.....10

**PRODUCT INSTALLATION**

Seat Installation.....11  
 Water Connection.....12  
 Remote Installation.....13  
 Installing & Replacing Battery Box.....14  
 Testing.....15

**PRODUCT OPERATION**

How To Use.....17  
 Maintenance.....21  
 Specifications.....23  
 Warnings & Safety.....24  
 Troubleshooting.....30

**WARRANTY**

Warranty.....34

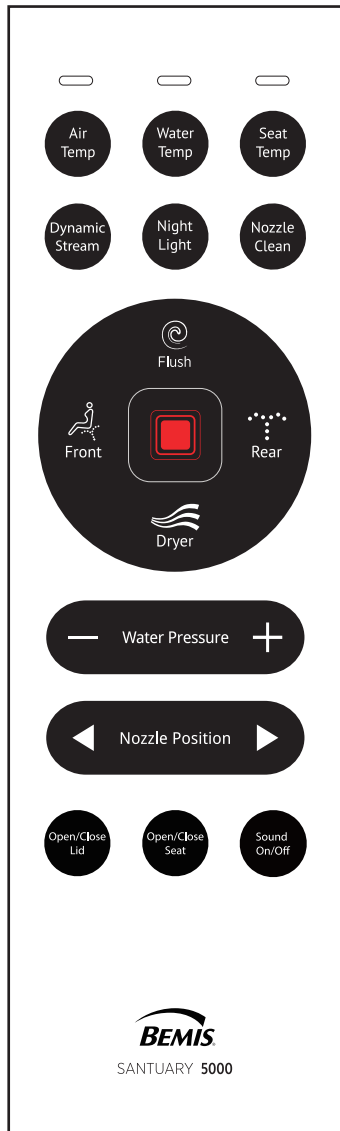

**OPEN/CLOSE LID**

Press to open or close the lid.

**OPEN/CLOSE SEAT**

Press to open or close the seat.

**SOUND ON/OFF**

Press to turn the beeping sound on/off.

**FLUSH**

Activates flush. The seat must be unoccupied.

**FRONT**

Press to activate the oscillating front wash. Press again to turn off oscillation.

**REAR**

Press to activate the oscillating rear wash. Press again to turn off oscillation.

**STOP**

Press to stop any operations.

**DRYER**

Press to activate the warm air dryer. Press again to adjust the fan speed.

**AIR TEMP | WATER TEMP. | SEAT TEMP.**

Press the corresponding buttons to adjust the temperature settings on each feature.

- **Low** - Blue
- **Medium** - Purple
- **High** - Red

### **DYNAMIC STREAM**

Press during a wash to quickly alternate between hot and cold water. This feature assists in stimulating bowel movements.

### **NIGHT LIGHT**

Press to turn the night light on/off.

### **NOZZLE CLEAN**

Press to extend the nozzle for manual cleaning. This feature can only be activated when the seat is not occupied.

### **WATER PRESSURE**

The water pressure starts off low. Press the + or - buttons to adjust the water pressure accordingly.

### **NOZZLE POSITION**

Press the arrow keys to adjust the position of the nozzle accordingly.

### **ULTRAVIOLET STERILIZATION**

This feature automatically activates after a wash cycle. The seat cannot be used during this time. This feature can only be activated when the seat is not occupied.

### **POWER/STOP BUTTON**

Short press to power on or long press to enter standby mode. Short press while powered on to stop any operations.

- When the power button is **red**, it is ready to use.

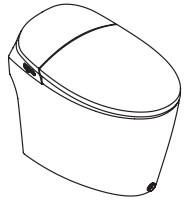

Intelligent Toilet



T-Valve with conversion nut



CR2030 Button Battery (2pc)



Floor installation template



Remote Control (holder 1pc, screw 2pc)



Wax Ring (1pc)



2 Water Supply Hoses



Floor flange (1pc)  
Washer (8pcs)  
Hexagon bolt (4pcs)

**Required Tools**



Drill (Dia. 0.24in)

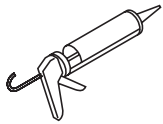

Silicone Gun



Teflon Tape

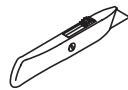

Knife



Marking Pen



0.91-0.98in  
(Spanner model varies for different pipes)

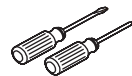

Screwdriver



Measuring Tape

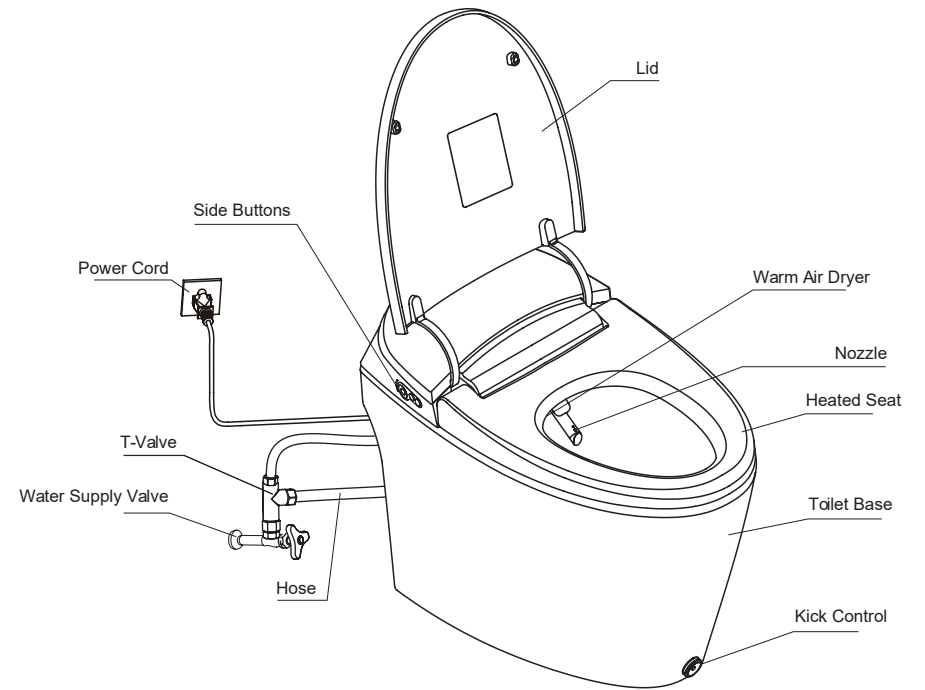

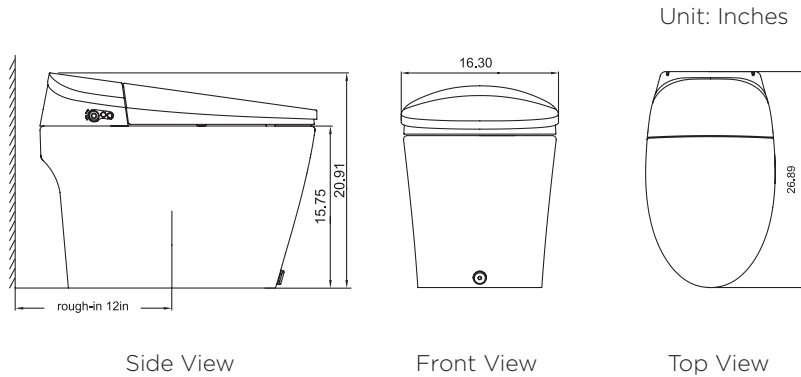

### Check Your Water Supply

The lowest acceptable water pressure is 0.14 MPa. The highest acceptable water pressure is 0.75MPa. The toilet cannot reach full cleaning functionality if the water pressure cannot reach 0.14MPa.

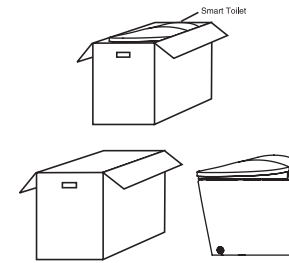

1. Open the box right side up. Remove the accessories first, then remove the unit from the top as shown in the diagrams above.

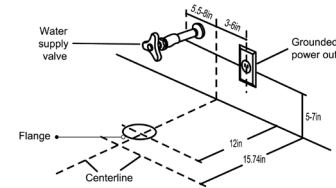

2. Prepare for installation by removing the existing toilet and cleaning the area near the flange.

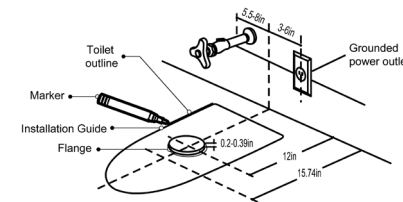

3. Place the installation guide over the flange and mark the perimeter with a temporary marker.

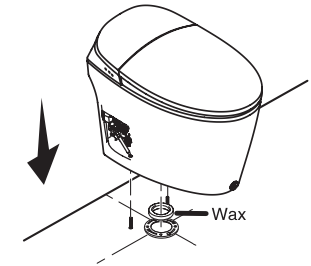

4. Place the wax ring and toilet base and position the wax ring on the flange. Remove the access covers and cap from the water inlet on the back of the toilet. Align the toilet over the flange and bolts. Carefully lower the toilet into the flange.

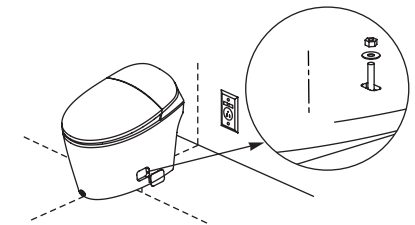

5. Secure the toilet base. Press down evenly on the toilet to set the wax ring. Install a washer and nut onto each bolt. Hand tighten the nuts. Use a wrench to tighten the nuts one quarter turn beyond hand tight.

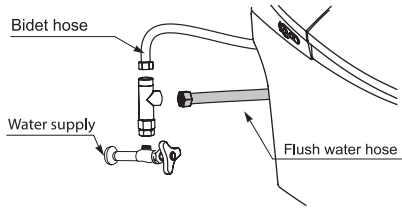

1. Attach the toilet hose to the T-valve and Sanctuary 5000.

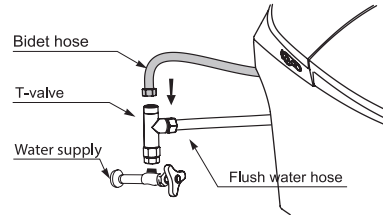

2. Attach the bidet hose to the T-valve and Sanctuary 5000.

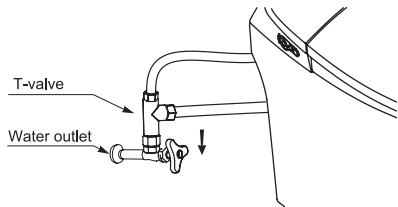

3. Connect the T-Valve to the water supply valve.

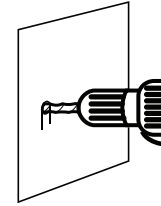

1. Drill two 6mm holes on the wall that line up with the remote bracket.

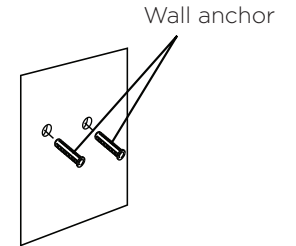

2. Install the wall anchors in the newly drilled holes.

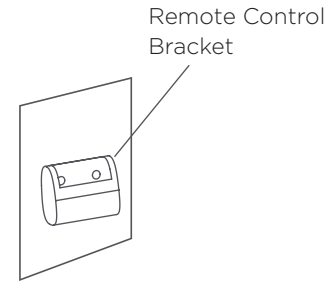

3. Place the remote bracket over the wall anchors.

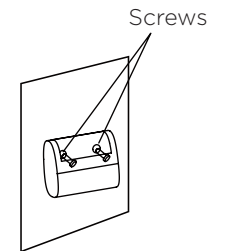

4. Use the provided screws to attach the remote control bracket to the wall.

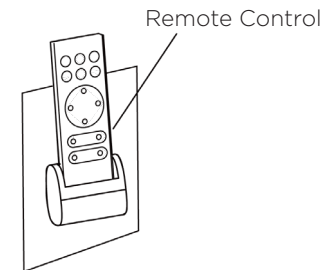

5. Place the remote control on the bracket.

**Installing The Battery Box**

1. Remove the extension cable from the back of the bowl (The cable is attached inside the back of the toilet. Tug it gently to let it free.)
2. Plug the cable into the battery box. Then, secure the water-proof nuts.

Place the battery box in its proper position shown on the right. The batteries and cables are divided into positive and negative poles. Do not forcefully connect them. Doing so may damage the product. If you have any questions, please call Bemis at 920.467.4621.

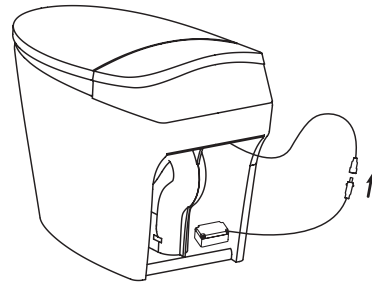

**Replacing The Battery Box**

1. Loosen the battery box screws and remove the cover. Remove the battery and safely discard it.
2. Load the new CR-P2 battery and re-secure the screws.
3. Place the battery box back into its place.

The battery should be kept out of children's reach. Please ensure that the battery's polarity is correctly matched. If they are incorrect it may lead to chemical leaks or explosions. The battery box is water proof so please make sure all the screws are tightly secured to ensure that the box is perfectly sealed.

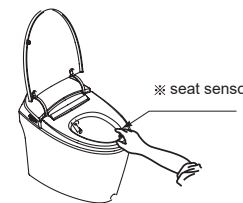
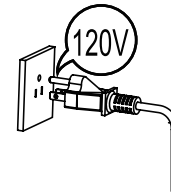
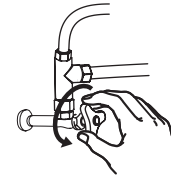
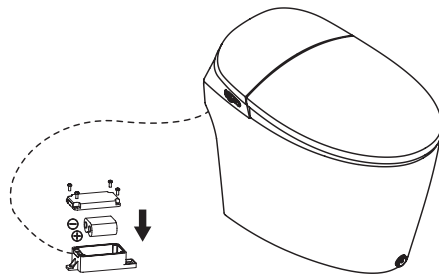

**Testing the Water Flow**

1. Open the water supply valve.
2. Check each connection for leaks
3. If leaks occur, turn off the water supply valve and re-connect the leaking components.

**Connecting Power**

1. Plug in the power cord.
2. Check to see if the power light is on. If not, push the reset button.
3. Once the power light is on, the toilet will run its initial diagnostics: lights will turn on, cleaning nozzle will extend, the motor will begin to run and water will run through the system. Once the light is off, the self-diagnostic is complete.

**Testing the Product**

1. Are all the functions working properly? Please test all of the following functions: Posterior Wash, Front Wash (including water pressure and nozzle position adjustment), Heated Dryer, Water and Seat Temperature Adjustment, Nozzle Cleaning, Deodorization, and Remote Control.
2. To check the posterior wash, place a hand on the sensor point (shown in the illustration), press Posterior on the Side Control Panel or the wireless remote. Use your hand to block the nozzle spray.





### Matching Your Remote Control Code

Your remote control will be matched with a code at the time of delivery. In the case that your remote control malfunctions, match the codes as per the following method.

1. Unplug your product. Press and hold the stop key until the level indicators flicker.
2. Place the remote control close to the product and plug your product back in.
3. The level indicator should stop flickering and all lights should be on normally. All level indicators should light up red (normal).
4. Codes are matched properly when all lights are on.

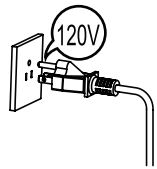

### Power on/off Button

Push the button to power on. Push and hold the button to power off. Press during a wash to stop all operations.

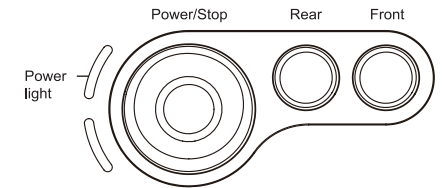

### Auto Rear Wash

Press the auto rear wash button. When seated, press the auto rear button to start a rear wash for 1 minute, followed by the dryer function for 4 minutes. If you press the button again during a wash, it will skip to the dryer.

**NOTE:** After 24 hours, product will automatically go into power saving mode and all functions will shut off. To turn back on, simply push the Power button on the Side Control Panel.

### Auto Front Wash

When seated, press the auto front button to start a rear wash for 1 minute, followed by the dryer function for 4 minutes. If you press the button again during a wash, it will skip to the dryer.

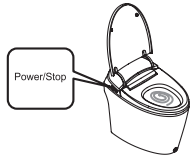

**Blackout Flush**

When the product is unplugged, press the Power/Stop button. If the toilet is not flushing properly, replace the battery.



**Auto Flush**

When the seat sensor no longer detects a user, it will automatically flush. The toilet will only flush once.



**Kick Open/Close the Lid and Seat**

Tap the “Kick Button” with your foot to raise your toilet seat/lid.

**Tap the kick button once:**  
Lid opens.

**Tap the kick button twice:**  
Seat raises.

**Tap the kick button three times:**  
Seat and Lid will close and the toilet will flush.

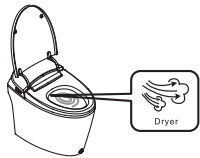

**Dryer Flush**

Press the “Dryer” button. The warm air function is activated and a flush is performed.



**Kick Flush**

Tap the Kick Button with your foot for easy manual flushing. Wash functions cannot be used during a flush.

**User-Friendly Design**

1. **Slow-closing lid/seat.** Preserve your toilet's life and allows you to close the lid/seat silently.
2. **Water purification.** Equipped with dedicated filter to ensure your bidet will only spray clean, filtered water.
3. **8 Layers of Safety.** 8 different built-in safety features to protect the user and product.
4. **Memory mode.** After loss of power, temperature, pressure, and nozzle position settings are restored to default settings. The night light will turn on by default.

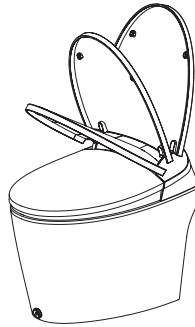

**Regular Maintenance Is Required To Ensure Normal Use.**

**Note:** Cut off the power and water supply before maintenance. Direct water wash to the entire product is prohibited.

**Maintenance Of Product Surface and Ceramics**

1. Wipe dust or stains with a soft wet cloth.
2. A wet soft brush, cloth, or sponge may be used to clean the ceramic area. Do not use abrasive cleaning solutions, such as alcohol, bleach, paint thinner, cresol, benzene, gasoline, etc.



**Maintenance Of The Nozzle**

1. Press the "Nozzle Clean" button on the remote control without occupying the seat. The nozzle will extend. Proceed to clean with a soft toothbrush. **Do not forcefully hold the nozzle.**

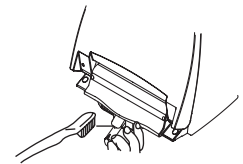

**Warning**

Do not spray water or detergents on the toilet, remote control or the power cord. Doing so may cause electric shock or fire.

**Maintenance During Winter Season**

During winter season, the water inside may freeze after long periods of storage and non-usage. Please take measures to prevent.

**Note**

Before connecting the product to the water supply and electrical outlet, allow it to defrost for 30 minutes in a warm indoor environment. In cases of extreme cold/freezing/nozzle stuck in place, wrap the water input line with a warm towel. Never pour hot water or use a hot dryer directly on the toilet.



|                                  |                              |   |
|----------------------------------|------------------------------|---|
| Rated voltage                    |                              | 120V  |
| Frequency                        |                              | 60Hz  |
| Rated power input                |                              | 1050W (When inlet water temp in 59°F)                           |
| Seat and dryer temperature range |                              | 93.2°F-104°F  |
| Water temperature range          |                              | 39.4°F- 95°F  |
| Water supply hose type           |                              | DN15 (G1/2")  |
| Water Inlet                      | Maximum Pressure             | 14.5 psi (Maximum flowing speed: 17L/min)                       |
|                                  |                              | 108.78 psi (static state)                                       |
| Toilet                           | Flush consumption            | ≤1.28 gal   |
|                                  | Flush type                   | Tornado flush   |
|                                  | Rough-in                     | Rough-in 12in   |
| Nozzle                           | Heating Type                 | Instant Heating   |
|                                  | Rear wash water consumption  | 0.11-0.2 gal/min (3 Levels) when inlet water pressure is 29 psi |
|                                  | Front wash water consumption | 0.11-0.2 gal/min (3 Levels) when inlet water pressure is 29 psi |
|                                  | Washing temp. range          | OFF/86°F-104°F (4 Levels)                                       |
| Safety system                    |                              | Butterfly thermostat, thermal fuse, flow sensor                 |
| Dryer                            | Dryer temp. range            | OFF/95°F-131°F (4 Levels)                                       |
|                                  | Air speed                    | >4m/s   |
|                                  | Power input                  | 350W  |
|                                  | Safety system                | Thermal fuse, bi-metal  |
| Heated seat                      | Heat temp. range             | OFF/82.4°F-104°F (4 Levels)                                     |
|                                  | Power input                  | 35W   |
|                                  | Safety system                | Thermal fuse  |
| Remote Control                   | Heat temp. range             | 7.48 in(L) 2.17in(W) 0.63 in(H)                                 |
|                                  | Power input                  | CR2030 Button Battery (2pcs)                                    |
| Power cable length               |                              | Appx. 47.2 in   |
| Product dimension                |                              | 26.89 in (L) 15.75in (W) 16.30in (H)                            |
| Product weight                   |                              | 84.88 lb (Electric part 16.53 lb, Ceramic part 68.34 lb)        |

**Please Read Thoroughly**

First of all, thank you for purchasing our product. To ensure proper and safe use of this product, carefully read this section prior to any usage. Afterwards, store this manual in a safe place for any needed future reference.

The hazards and warnings listed herein are important to our user’s safety. Significant consequences may result from failure to heed warnings. **The company will not be held liable for any injuries to the user and damages to the product due to improper usage and/or failure to heed safety warnings.**

**WARNING**

- This product needs to be properly grounded. Risk of electric shock. If unsure, contact an electrician.
- Do not touch, insert, or pull out the power plug with a wet hand. Risk of electric shock.
- Do not use a power socket in poor condition or a damaged power plug. Risk of fire and/or electric shock.
- The power socket in use should be within the specified range (AC120V). Risk of fire and/or electric shock.
- Do not pull, damage, bend, twist, stretch, roll, bundle, clamp, or squeeze the power cable. Do not place anything on the power cable. Risk of fire and/or electric shock.
- If the power cord is damaged, to prevent any injuries or accidents, it should be replaced by a professional. Risk of fire and/or electric shock.
- Do not place a lit cigarette along with other burning objects into the unit. Risk of fire.
- Do not use during thunderstorms (pull out the power plug during storms). Failure in doing so may lead to injury or fault in the product.
- When the seat ring or the cover plate is damaged, to avoid any harm, be sure to pull off the power plug, close the water source and contact your local distributor for replacement. Risk of fire or electric shock.

- Regularly pull out the power plug and wipe off any dust on the power plug using a clean dry cloth. Risk of fire.
- Any person with a disability, the elderly, and children, should be using this product with the supervision of another individual. Be advised that sitting on the heated seat for an extended amount of time may result in burns.
- This product is not a toy. Advise children not to play with product. Risk of injury.
- Do not dismantle, repair or alter this product on your own. Contact Bio Bidet for assistance. Risk of fire, electric shock, and/or other accident that may lead to injury.
- For cleaning or maintenance of plastic parts, do not use any harsh cleaning agents. (These include, but are not limited to products such as; concentrated sulfuric acid, carbon tetrachloride, chloroform, acetone, butanone, benzene, methylbenzene, phenol, methylphenol, dimethylformamide, methyl ether, soybean oil, acetate, 40% nitric acid, thick salt acid, 95% alcohol, gasoline, kerosene or brake oil, etc). Risk of damaging parts that can lead to accidents and injuries.
- Do not add water or detergent into the unit or on to the wireless remote. Do not soak the product with water or cleaner. Risk of fire and/or electric shock.
- Do not install the product in a humid environment or a soak room. Do not spray or soak this product with any form of liquid to prevent any damage to the product. Risk of fire and/or electric shock.

- Do not install product in a humid environment or a soak room. Do not spray or soak this product with any form of liquid to prevent any damage to the product. Risk of fire and/or electric shock.
- Do not use polluted water or water meant for industrial. Risk of urocystitis or dermatitis. Unrelated water may also cause electrical shock or a fire.
- Do not apply any force to the unit's seat and lid. Do not stand on the lid or open or close the lid and the seat forcefully. This may result in product damage and/or user injury.
- Do not place your hand or any other object into the dryer trap, and do not cover the dryer and dryer trap during product use. Risk of fire, electric shock, and/or other accident that may lead to user injury.
- Do not spray urine at the dryer trap. Risk of electric shock.

### **Read the following for proper battery usage.**

1. Properly install the battery according to its correct polarity.
  2. Remove the battery during long periods without use.
  3. Replace the battery before it reaches the end of its usage. Failure to do so may result in interrupted control signals.
  4. Cover the battery with tape before disposal. This will prevent battery fluid leaks that may cause fire and/or other damages.
- Place the battery out of reach of children and infant reach. If battery is swallowed, contact a doctor immediately.
  - If battery fluid leaks onto user, quickly rinse off area using water.
  - If battery fluid gets into eyes, do not rub your eyes. Quickly rinse it with water and consult a doctor immediately. May result in vision impairment or blindness.

### **When the battery is in use, do not do the following operations.**

- Do not hold or store with metal objects (such as necklace or watch).
- Do not mix new and old batteries.
- Do not pull battery apart or throw it into water and/or fire. Battery fluids may cause a fire.

### ATTENTION

- Do not use the heated seat or warm dryer temperature for an extended amount of time. Extended use may result in burns.
- While using this product, make sure that the skin is in contact with the seat sensor area. Otherwise, product may not operate correctly. Children and smaller individuals may have trouble staying in contact with sensor area.
- Do not spray urine in the direction of the bidet nozzle. Doing so may result in blockage to the bidet nozzles and cleaning area.
- Do not use your old hose component. Use the one provided with your product. Anything else connected to the older hose may need to be replaced. Risk of water leakage and/or property loss/damage.
- In case of sudden power failure, remove the power plug and close the angle valve to prevent water leakage. Risk of water leakage and/or property loss/damage.
- Avoid direct sunlight or heat. Risk of product discoloration.
- Do not supply electricity with an external switch. ie: connecting the universal part to a timer switch. Run the risk of issues caused by improperly resetting the thermal breaker.
- When the filter is being replaced, be sure to close the water supply angle valve. When the filter is being installed, be sure to fasten it with force. Risk of water leak.
- Pull out the power plug when the product is in disuse for an extended amount of time. Make sure to shut off the water and remove the water inside the product. Risk of fire, leaks, and product damage.
- When storing or transporting in cold climate, make sure to remove all water from the unit. Product may crack and other damages may occur due to freezing water. Risk of fire, leaks, and product damage.

### Experiencing Issues With Your Product?

If you experience any issues, please consult the troubleshooting guide below. If the problem persists, contact Bemis support.

#### Power/Stop

| Issue                  | Diagnosis                            | Solutions                  |
|------------------------|--------------------------------------|----------------------------|
| Product is not working | Check if the power cord is loose.    | Please check the circuit.  |
|                        | Check if the product is powering on. | Press "Power/Stop" button. |

#### Dryer

| Issue                     | Diagnosis   | Solutions                           |
|---------------------------|---|-------------------------------------|
| The dryer blows cold air. | Check the dryer settings.                                     | Adjust the dryer settings.          |
|                           | Check whether the heating element of dryer is damaged or not. | Contact Bio Bidet by Bemis Support. |

#### Heated Seat

| Issue  | Diagnosis                            | Solutions  |
|--|--------------------------------------|--|
| The temperature of toilet seat is too low or is not heating. | Check the seat temperature settings. | Regulate the temperature of the toilet seat according to the instruction manual. |

#### Wash Functions

| Issue  | Issue   | Solutions  |
|--|---|--|
| No water in the nozzle.                        | Check whether the water supply cuts off or not.         | Restore the water supply.                                      |
|  | Check whether the angle valve switches off or not.      | Open the angle valve.  |
|  | Check whether the water inlet filter is blocked or not. | Clean the filter mesh or change the water filter.              |
|  | Check whether the inlet pipe is flexed or not.          | The inlet pipe must be straight.                               |
| The water pressure is too low.                 | Check the water pressure settings.                      | Increase the water pressure settings.                          |
|  | Check whether the inlet filter is blocked or not.       | Clean the filter mesh or change the water filter.              |
| Unusual water flow from the nozzle.            | Abnormal operation                                      | Unplug the unit for the one minute before plugging it back in. |
| The water temperature is not warm enough.      | Check the water temperature settings.                   | Increase the water temperature settings.                       |
| Water is leaking from the nozzle.              | Solenoid valve no longer has any effect.                | Contact Bemis Support.   |
| The cleaning function is not working normally. | Seat sensor malfunction.                                | Contact Bemis Support.   |

#### Remote Control

| Issue                          | Diagnosis   | Solutions            |
|--------------------------------|---|----------------------|
| The stop key is flashing.      | Low Battery   | Replace the battery. |
| Remote control is not working. | Check whether there is any water on the remote control. | Wipe off the remote. |



**Toilet Unit**

| Issue   | Diagnosis                              | Solutions   |
|---|--|---|
| The product is not flushing clean when water pressure is low. | The filter is blocked.                 | Clean filter according to the instructions manual.  |
|   | The water pressure at home is too low. | Check whether the water amount is below 3L every 10 seconds or not. If it is, we suggest you buy a pressure increasing valve. |
|   | The hose is bent.                      | Reconfigure the hose to a more smooth connection.   |
| Flusher is not working.                                       | Flush valve breakdown.                 | The inlet pipe must be straight.  |

**Soft-Close Feature**

| Issue  | Diagnosis                             | Solutions  |
|--|---------------------------------------|--|
| The toilet seat/toilet cover opens or closes too fast. | Slow close damper is not functioning. | Contact Bio Bidet by Bemis Support.                        |
| Kick Button is not functioning.                        | Slow close damper is not functioning. | Unplug the unit for one minute before plugging it back in. |

## 2 Year Preferred Warranty Coverage

Bio Bidet Innovation LLC warrants the Sanctuary 5000 to be free from manufacturing defects under normal use for a period of 2 years from the date of purchase.

Our obligation to you under this warranty is limited to repair or replace, at our option, of defective products or parts, provided the products were properly installed and used in accordance with the instructions. We reserve the right to make inspections in order to determine the cause of defect. We will not charge for labor or parts in the connection with warranty repairs or replacements. We are not responsible for the cost of removal, return, and/or re-installation of products.

This warranty does not apply to:

1. Damage or loss from a fire, earthquake, flood, storm, etc.
2. Damage or loss resulting from any unreasonable use, abuse, negligence, or proper maintenance.
3. Damage or loss from improper installation, removal, repair, or modification.
4. Damage or loss resulting from sediment or other matters contained in your water system.

This warranty gives you specific legal rights.

For warranty service information, please contact your dealer or Bio Bidet Innovation LLC. Only the original purchaser may submit a claim under this warranty.

This warranty is our only warranty covering your product. Repair or replacement as provided under this warranty shall be the exclusive remedy available to you. We shall not be responsible for loss of the product or for other incidental, or consequential damage or expenses you may incur for labor or other costs due to installation or removal, or cost of repairs by others, or for any other expense not specifically stated above. Except to the extent prohibited by applicable law, any implied warranty.

**WARNING!** We are not responsible for liable for any failure of, or damage to, this plumbing product or product component caused by in-tank bowl cleaners containing chlorine (calcium hypochlorite).

**NOTE:** The use of high concentration chlorine related products can damage the product fittings. This damage can cause leakage and serious property damage.

# Thank You



300 Mill Street  
Sheboygan Falls, WI 53085  
T: 920.467.4621

[Bidets@Bemismfg.com](mailto:Bidets@Bemismfg.com)  
[ToiletSeats.com](http://ToiletSeats.com)