

30"

Item Number:  
E444-CU30-MCA

JAMES MARTIN



VANITIES™

Addison 30" Free-standing Countertop Unit  
Diagrams with Dimensions  
page 01 of 03

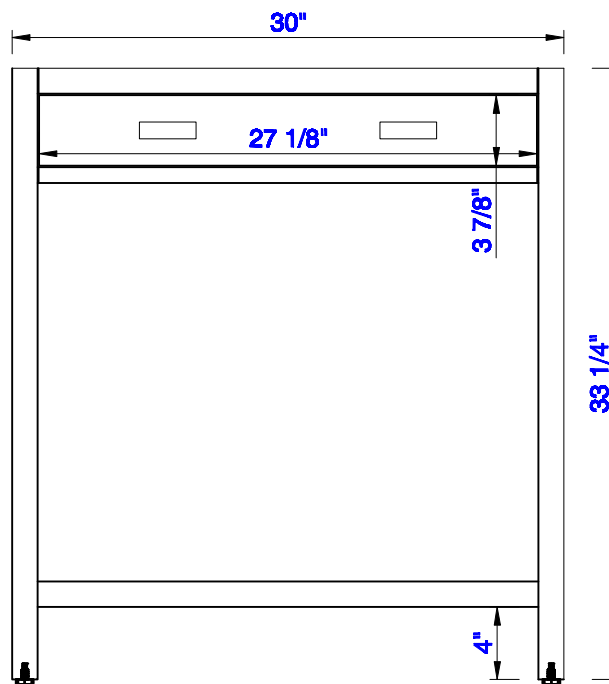

NOTE ONE: Countertops are not shown in these diagrams. (Cabinet Only)

NOTE TWO: This vanity does not have a Backsplash.

Please consult our website for Countertop Diagrams: [www.jamesmartinvanities.com](http://www.jamesmartinvanities.com)

Version:202004

30"

Item Number:  
E444-CU30-MCA

JAMES MARTIN

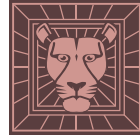

VANITIES™

Addison 30" Free-standing Countertop Unit  
Diagrams with Dimensions  
page 02 of 03

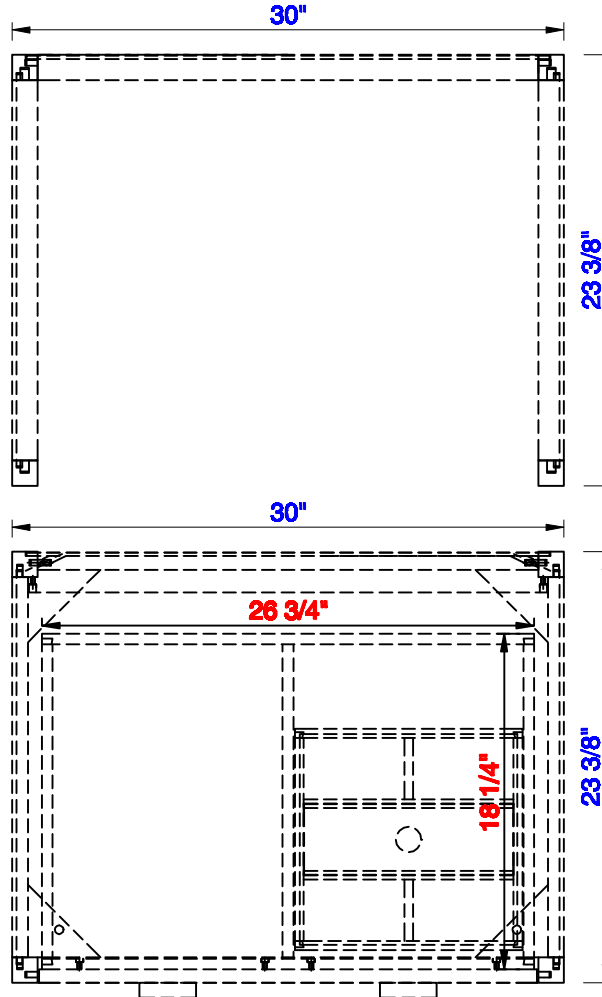

**NOTE ONE: Countertops are not shown in these diagrams. (Cabinet Only)**  
Please consult our website for Countertop Diagrams: [www.jamesmartinvanities.com](http://www.jamesmartinvanities.com)

Version:202004

30"

Item Number:  
E444-CU30-MCA

JAMES MARTIN

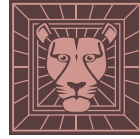

VANITIES™

Addison 30" Free-standing Countertop Unit  
Diagrams with Dimensions  
page 03 of 03

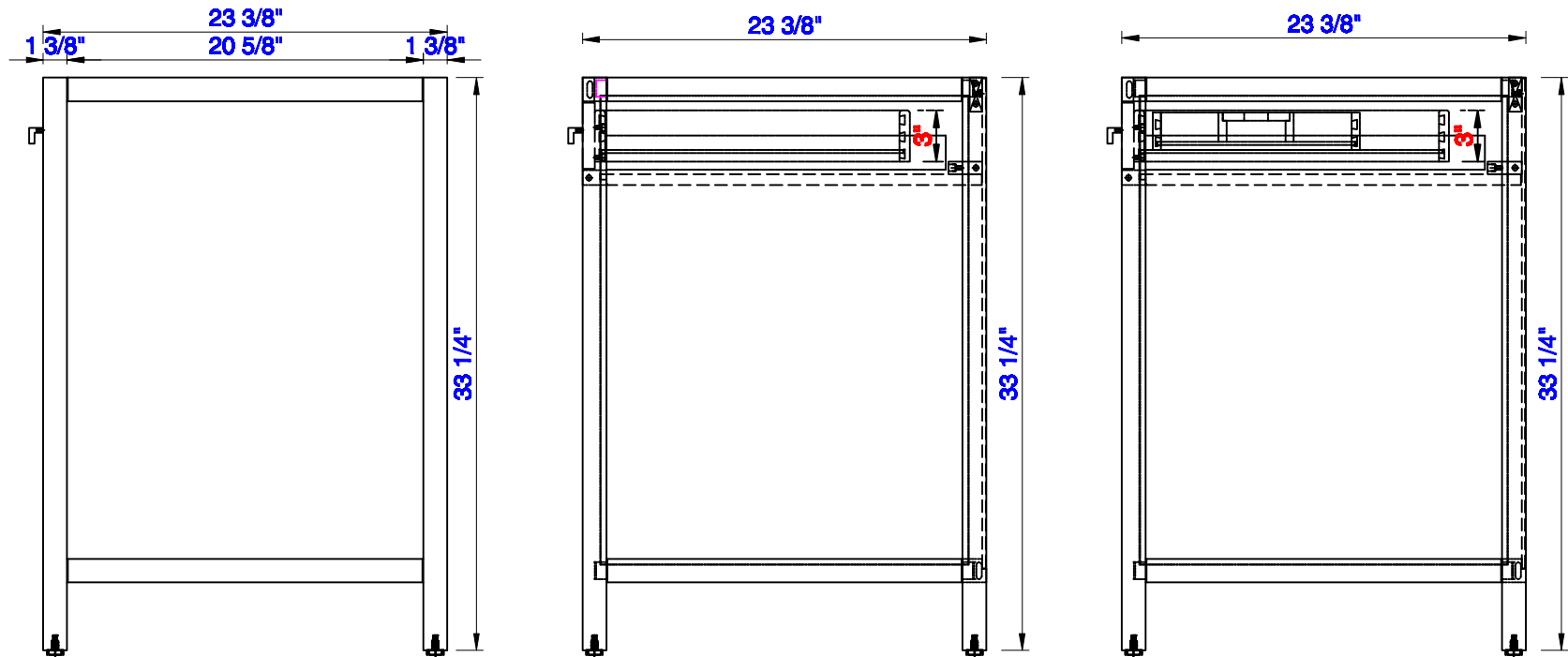

NOTE ONE: Countertops are not shown in these diagrams. (Cabinet Only)

NOTE TWO: This vanity does not have a Backsplash.

Please consult our website for Countertop Diagrams: [www.jamesmartinvanities.com](http://www.jamesmartinvanities.com)

Version:202004

762mm

Item Number:  
E444-V30-MCA

JAMES MARTIN

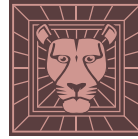

VANITIES™

Addison 762mm Free-standing Countertop  
Unit Diagrams with Dimensions  
page 01 of 03

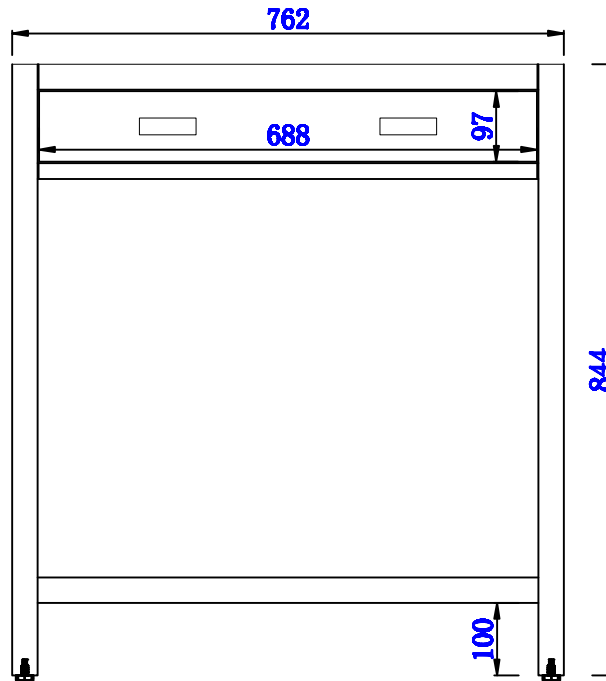

**NOTE ONE:** Countertops are not shown in these diagrams. (Cabinet Only)

**NOTE TWO:** This vanity does not have a Backsplash.

Please consult our website for Countertop Diagrams: [www.jamesmartinvanities.com](http://www.jamesmartinvanities.com)

Version:202004

762mm

Item Number:  
E444-V30-MCA

JAMES MARTIN



VANITIES™

Addison 762mm Free-standing Countertop  
Unit Diagrams with Dimensions  
page 02 of 03

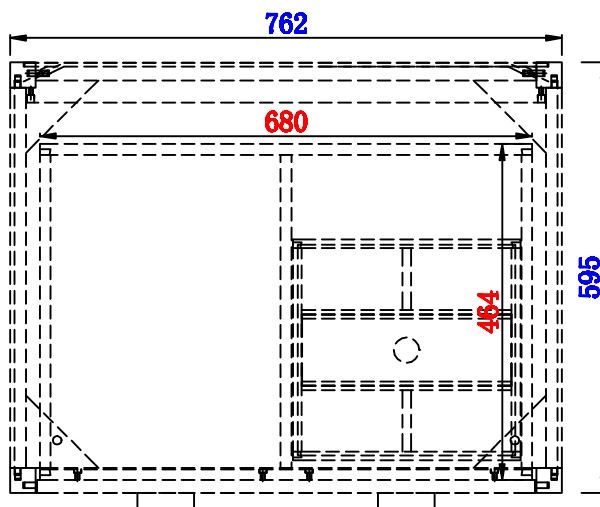
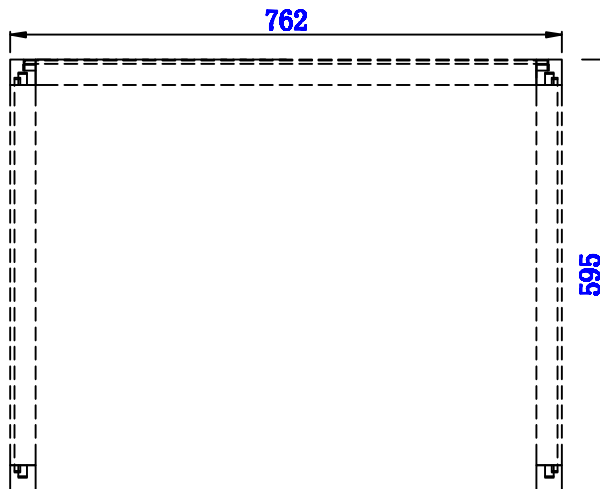

**NOTE ONE: Countertops are not shown in these diagrams. (Cabinet Only)**  
Please consult our website for Countertop Diagrams: [www.jamesmartinvanities.com](http://www.jamesmartinvanities.com)

Version:202004

762mm

Item Number:  
E444-V30-MCA

JAMES MARTIN



VANITIES™

Addison 762mm Free-standing Countertop  
Unit Diagrams with Dimensions  
page 03 of 03

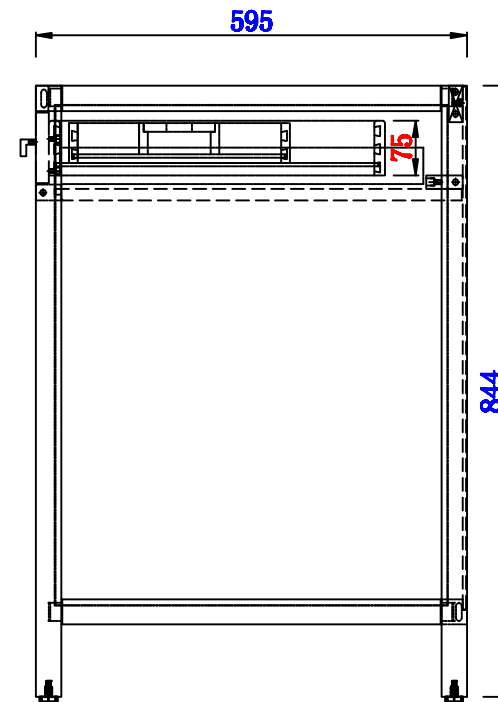
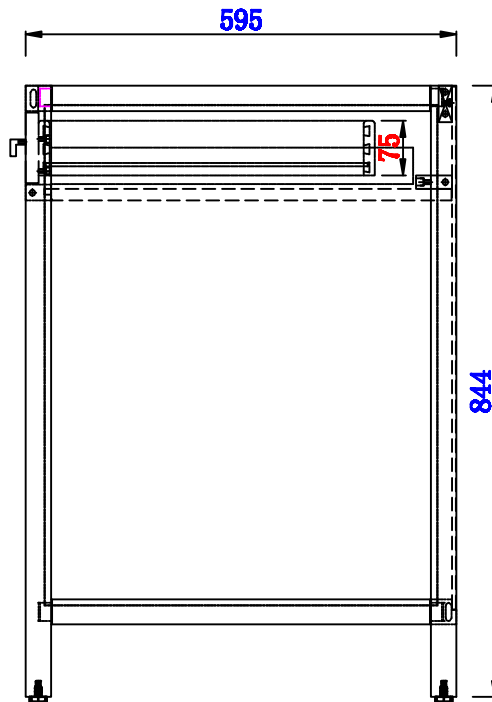
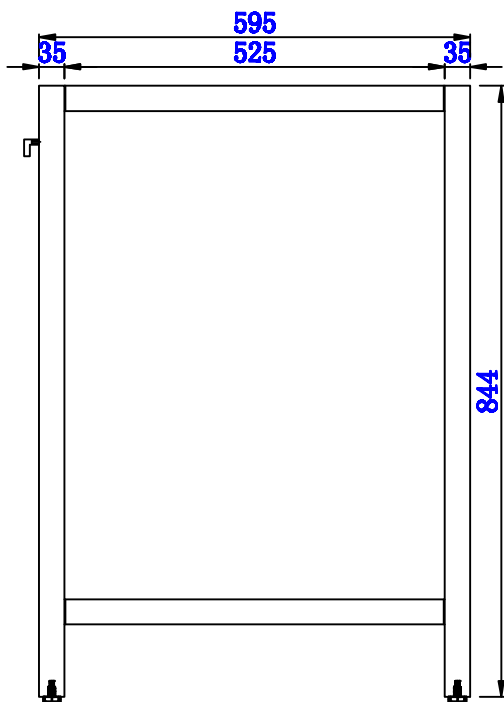

**NOTE ONE:** Countertops are not shown in these diagrams. (Cabinet Only)

**NOTE TWO:** This vanity does not have a Backsplash.

Please consult our website for Countertop Diagrams: [www.jamesmartinvanities.com](http://www.jamesmartinvanities.com)

Version:202004