

Designer Collection Shower Bases

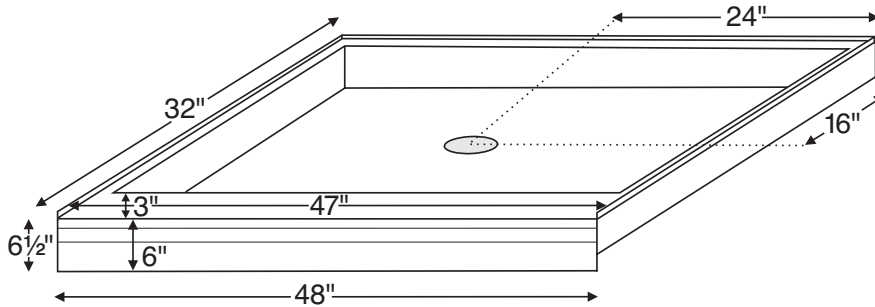

MTSB-4832

48" x 32" x 6" (exterior bottom of base)
SINGLE THRESHOLD textured floor
Center Drain
Acrylic CXL®
65 lbs / 29 kg



Model #	Size	Shape	MSRP
SB4832	48" x 32" x 6"	Rectangle	\$1,530

Options <i>Must be ordered at time of purchase</i>
Color Please specify color on order White (CWH) Biscuit (CBS)
Quick Ship (QSPRI) \$430 Reduces lead time. Please call for availability.
Radiance® (RAD100) \$1,595 Shower floor heating system. Radiance heating grids are fully integrated within the acrylic shell structure of the shower floor. Requires a 110-volt, 15 amp GFCI and remote installation of control box & keypad.
Pre-Levelled Foam Base (PLFSB) \$220
PVC Drain Kit Finishes Chrome included with shower base Brushed Nickel upcharge (SBDKBN) \$65

Accessories
Drain Kit Options Solid Brass Drain Kit with Stainless Steel Cover (SBDKSB) \$195
Teak Shower Seat Premium Natural Stainless (TK-SSEAT2416BNS) \$3,035 High-Polished Stainless (TK-SSEAT2416BHP) \$3,465 Standard Natural Stainless (TK-SSEAT2215NS) \$1,125 High-Polished Stainless (TK-SSEAT2215HP) \$1,575
Teak Bath Mat (TKMAT3018) \$815 Measures 30" x 17.5" x 1" Custom sizes also available. Contact MTI for details.
Teak Shower Tray (TK4832) Contact MTI for pricing

IMPORTANT ORDERING & INSTALLATION INFORMATION

- 3-sided integral tile flange to facilitate installation.
- Single threshold design.
- 3.5" drain opening pre-drilled.
- Drain finish options on this sheet are upcharge prices only. Contact MTI for ordering details for drain kits sold separately.
- Compliant with ASTM C 1028-07 coefficient of friction test.
- Add proper wet-bedding compound to fully support bottom of shower base. Optional factory installed Pre-Levelled Foam Base negates the need to wet bed when installing on a flat, level subfloor. See installation instructions.

• Options and accessories may be packaged inside the box. Always check packaging before discarding.
• All product measurements are ±1/2".
• Specifications and configurations are subject to change without notice.
• Measurements herein supersede all others published prior to publication date below.

See the Installation & Operation Manual for more details.
MTI's Customer Service: Monday-Friday 8am-6pm EST
800-783-8827 or service@mtibaths.com

CSA # MTSB-4832

©2023 by MTI Baths, Inc. Modification Rights Reserved



Rev. 03 29 2023