

Pfirst Modern™
LG142-060

Single Control Faucet
Grifo de Solo Control
Robinet de Commande Simple

Installation Support • Soporte de instalación • Support d'installation

Personal Assistance, Product Specs, & "How-to" Questions:

Asistencia personal, especificaciones del producto y preguntas sobre "cómo hacerlo":

Aide personnelle, spécifications du produit et questions « pratique-pratiques » :

1-800-PFAUCET (732-8238)

pfisterfaucets.com/support

Installation Videos Available
Videos de instalación a disposición
Vidéos d'installation disponibles



pfisterfaucets.com/videos



WARNING / ADVERTENCIA / AVERTISSEMENT

To reduce the risk of injury or property damage, read all instructions before installing product. Wear safety goggles. Product must be installed in accordance with all state & local plumbing & building codes. Call a professional if you are uncertain about installing this product.

Para disminuir el riesgo de lesiones o daños a la propiedad, lea todas las instrucciones antes de instalar el producto. Utilice gafas de seguridad. El producto deberá instalarse de acuerdo con la normativa de plomería y construcción estatal y local. Llame a un profesional si no está seguro sobre cómo instalar este producto.

Pour réduire le risque de blessures ou de dommages, lire toutes les instructions avant d'installer le produit. Porter des lunettes de sécurité. Le produit doit être installé en conformité avec tous les codes de construction et de plomberie locaux et de l'état. Appelez un professionnel si vous n'êtes pas certain de la façon d'installer ce produit.

Required Tools Herramientas necesarias Outils nécessaires

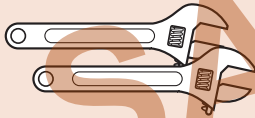

Adjustable Wrenches
Llaves ajustables
Clés à mollette



Safety Goggles
Gafas de seguridad
Lunettes de sûreté



Plumber's Putty
Masilla para plomería
Mastic de plombier

Additional Helpful Tools Otras herramientas útiles Outils supplémentaires utiles

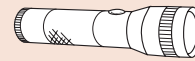

Flashlight
Linterna
Lampe De Poche



Cloth
Paño
Chiffon

Parts in the Box Piezas en la caja Pièces dans la boîte

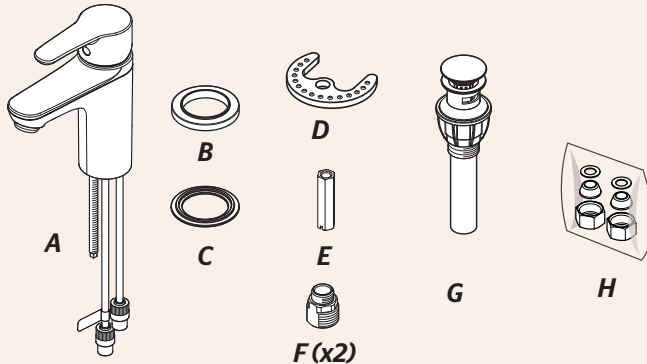

Items shown are not to scale.
De resultados no están a escala.
Produits affichés ne sont pas à l'échelle.

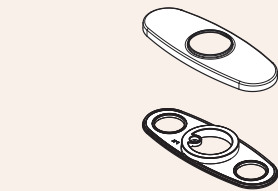

Optional Deck Plate (not included) see page 3.
Placa de cubierta opcional (no incluido), véase la página 3.
Plaque de pont en option (non inclus), voir page 3.

1 Turn Off Water Supply • Cierre el suministro de agua • Couper l'alimentation en eau



Locate water supply inlets and shut off the water supply valves. These are usually found under the sink or near the water meter. If you are replacing an existing faucet, remove the old faucet from the sink and clean the sink surface thoroughly.

Ubique las entradas del suministro de agua y cierre las válvulas de suministro de agua. Generalmente se encuentran debajo del fregadero o cerca del medidor de agua. Si se trata de un reemplazo de grifo, quite el grifo viejo y limpie completamente la superficie del fregadero.

Recherchez les entrées d'approvisionnement et fermer leurs robinets. Ces robinets se trouvent généralement sous l'évier ou près du compteur d'eau. Si vous remplacez un robinet existant, retirez, le vieux robinet de l'évier et nettoyez soigneusement la surface de ce dernier.

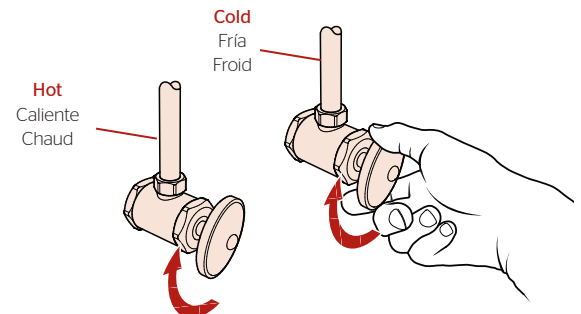

2

Install Faucet **without Deckplate**

Instale el grifo sin la placa de cubierta

Installer le robinet sans le plate-forme

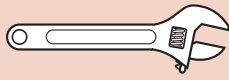

Adjustable Wrench
Llave ajustable
Clé réglable

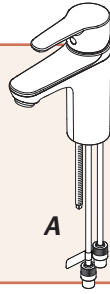

A

B

C

D

E

2A

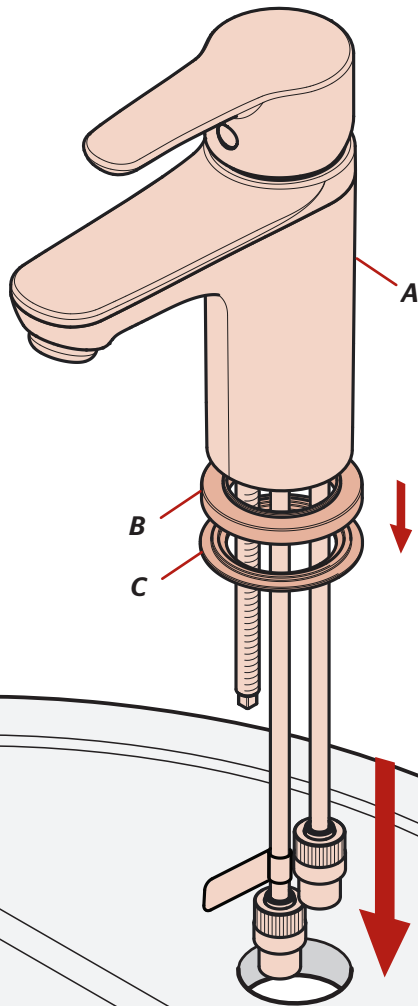

2B



Be sure the spout body (A) is centered & facing forward. IMPORTANT: DO NOT OVERTIGHTEN.

Cerciórese que la estructura del surtidor (A) esté centrada y orientada hacia adelante.
IMPORTANTE: NO APRIETE EXCESIVAMENTE.

Assurez-vous que le corps du bec (A) est centré et tourné vers l'avant.
IMPORTANT: NE PAS TROP SERRER.

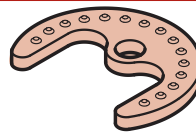

Bumps face up.

Topa cara arriba.
Cogne récepteur.

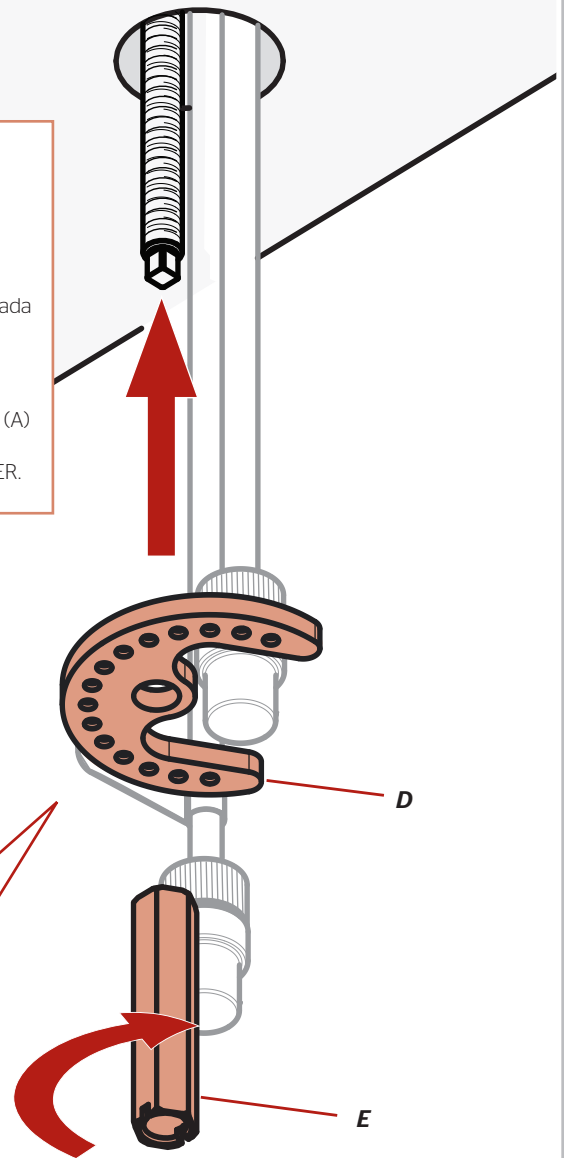

2 **OPTION: Install Faucet with Deckplate**
OPCIÓN: Instale el grifo con la placa de cubierta
OPTION: Installer le robinet avec le plate-forme

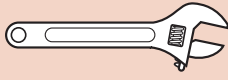

Adjustable Wrench
Llave ajustable
Clé réglable

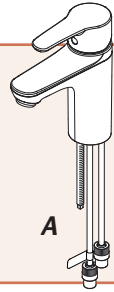

A



D



E

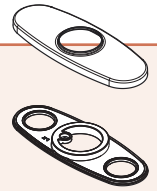

Optional Deck Plate: 961-217
Placa de cubierta opcional: 961-217
Plaque de pont en option: 961-217

2A

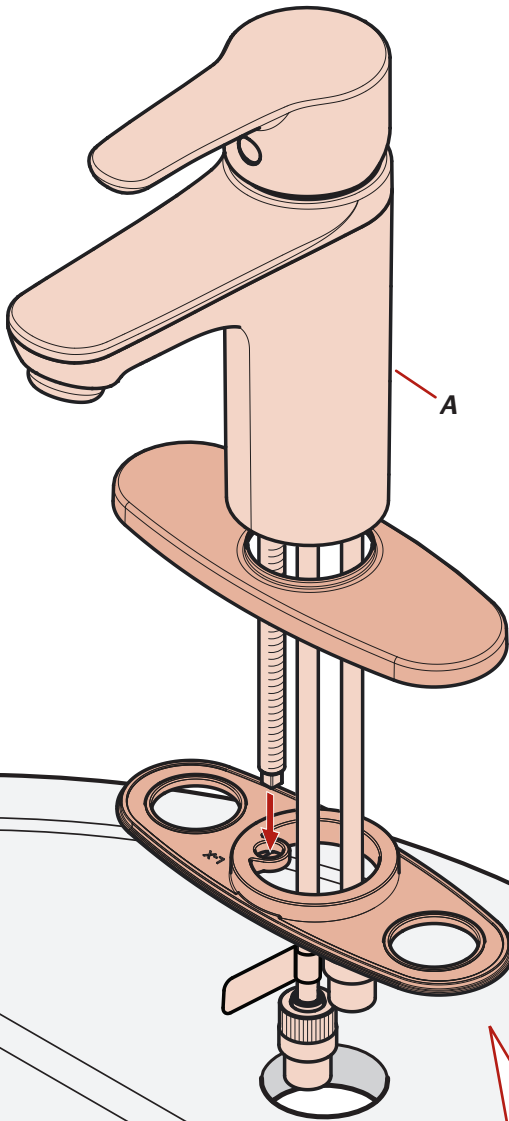

A



Be sure the spout body (A) is centered & facing forward. IMPORTANT: DO NOT OVERTIGHTEN.

Cerciórese que la estructura del surtidor (A) esté centrada y orientada hacia adelante.
IMPORTANTE: NO APRIETE EXCESIVAMENTE.

Assurez-vous que le corps du bec (A) est centré et tourné vers l'avant.
IMPORTANT: NE PAS TROP SERRER.

Optional Deck Plate, see Maintenance & Care Guide, page 2, Call 1-800-732-8238 to order.

Placa de cubierta opcional, consulte la Guía de Mantenimiento y Cuidado de la página 2, llame al 1-800-732-8238 para ordenar.

Plaque de pont en option, consultez le Guide de maintenance et d'entretien, page 2, Appelez 1-800-732-8238 à l'ordre.

2B

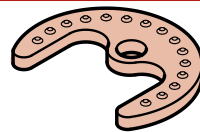

Bumps face up.

Topa cara arriba.
Cogne récepteur.

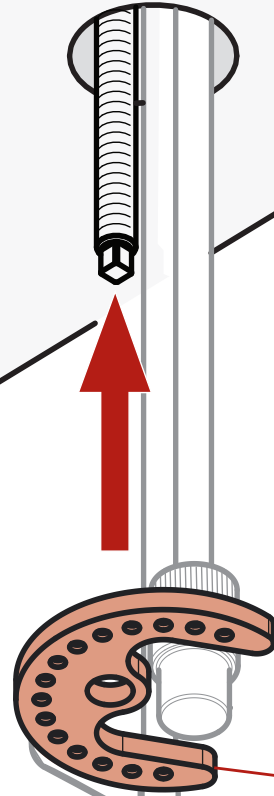

D

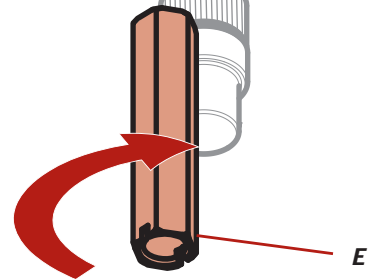

E

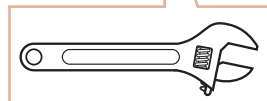

Apply Plumber's Putty in the groove along the bottom outer edge of Plate.

Aplique masilla de plomería en la ranura a lo largo del borde exterior de la placa inferior.
 Appliquez du mastic de plombier dans la rainure sur le bord extérieur de la plaque.



3 Connect Water Supply Lines Conecte las tuberías de suministro de agua Raccorder les conduites d'alimentation en eau

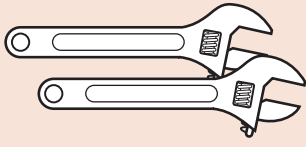

Adjustable Wrenches
Llaves ajustables
Clés à mollette



F (x2)



Water Supply Lines not included. Please consult manufacturer and/or its instructions for the correct method of installation of supply lines & fittings. IMPORTANT: Incorrect application of supply lines and fittings may result in the failure or leak of the supply lines and fitting.

Las tuberías de suministro de agua no están incluidas. Consulte por favor el fabricante y/o sus instrucciones para el método correcto de instalación de líneas de suministro y de guarniciones.

IMPORTANT: El uso incorrecto de líneas de suministro y de guarniciones puede dar lugar a la falta o al escape de las líneas de suministro y de la guarnición.

Les tuyaux d'arrivée d'eau ne sont pas fournis. Veuillez consulter le fabricant et/ou ses instructions pour la méthode correcte d'installation des conduites d'alimentation en eau et des accessoires.

IMPORTANT: Mauvaise application des lignes d'alimentation et accessoires peut entraîner la défaillance ou la fuite.

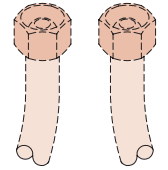

HOT
CALIENTE
CHAUD

COLD
FRÍA
FROID

3A

x2

Hot & Cold

Caliente y fría
Chaud et froid

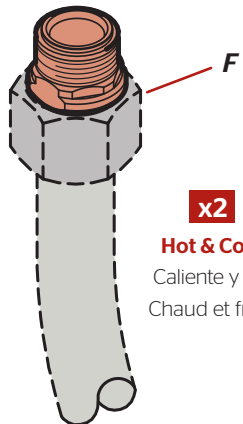
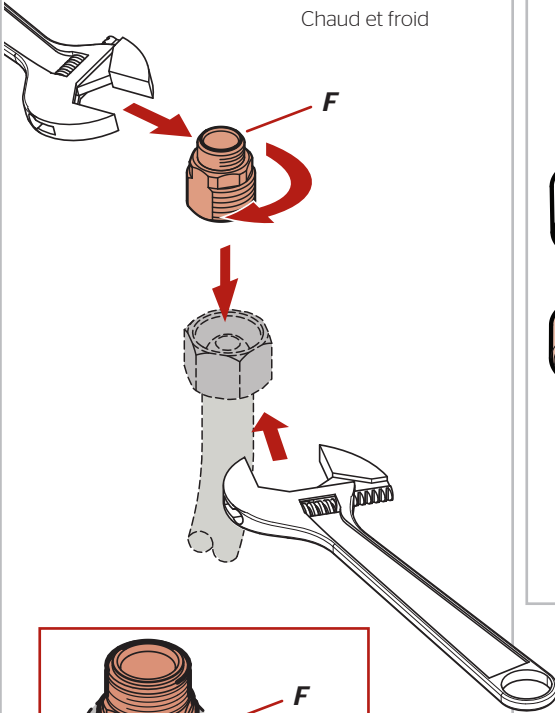

x2

Hot & Cold
Caliente y fría
Chaud et froid

3B

x2

Hot & Cold

Caliente y fría
Chaud et froid

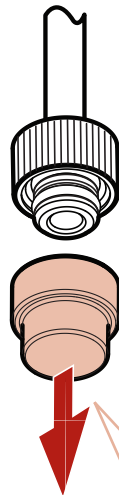

Package Only
Empaquetado solamente
Empaquetage seulement

Firmly hand tighten

Firmemente apriete a mano
Main serrez

x2

HOT
CALIENTE
CHAUD

3C



Separate tubes gently and slightly for clearance.

Tubos separados y ligeramente suavemente para su despacho.

Tubes séparés doucement et légèrement pour le dédouanement.

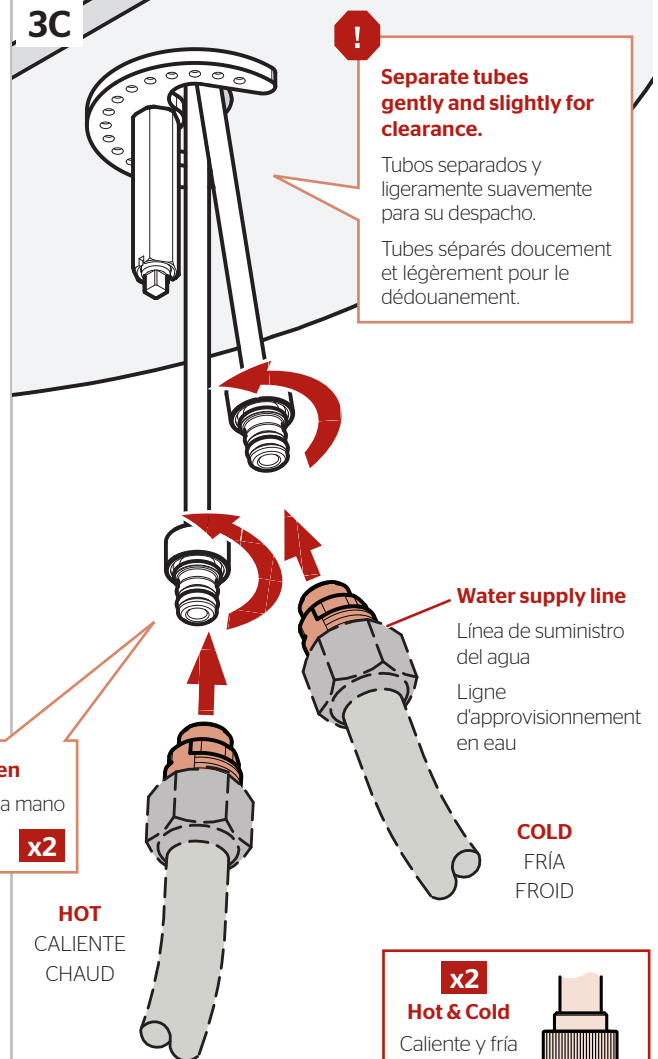

Water supply line

Línea de suministro del agua
Ligne d'approvisionnement en eau

COLD
FRÍA
FROID

x2

Hot & Cold

Caliente y fría
Chaud et froid

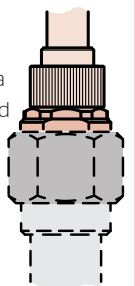

4 Prepare & Install Push & Seal™ Drain

Prepare y instale cuerpo de drenaje Push & Seal™

Préparez & installez le corps de drainage Push & Seal™

No Tools Required for This Step
 No se necesitan herramientas para este paso
 Pas d'outil nécessaire pour cette étape

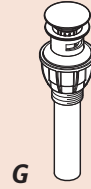

4A Disassemble Pop-Up

Desensamble el cuerpo de drenaje

Démontez le corps de drainage

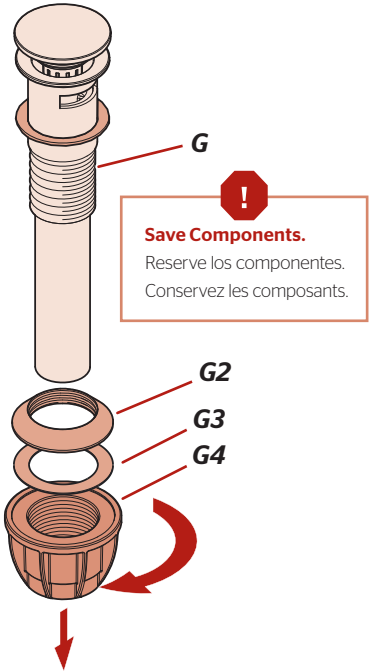

Save Components.
 Reserve los componentes.
 Conservez les composants.

4B

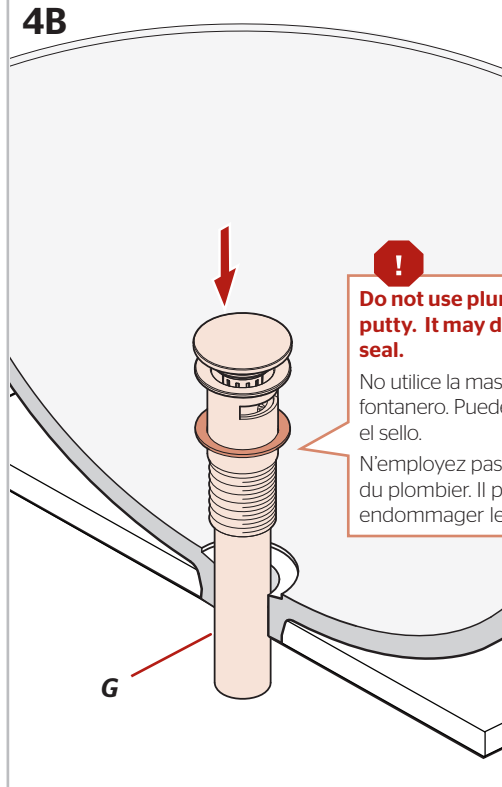

Do not use plumber's putty. It may damage seal.
 No utilice la masilla del fontanero. Puede dañar el sello.
 N'employez pas le mastic du plombier. Il peut endommager le joint.

4C

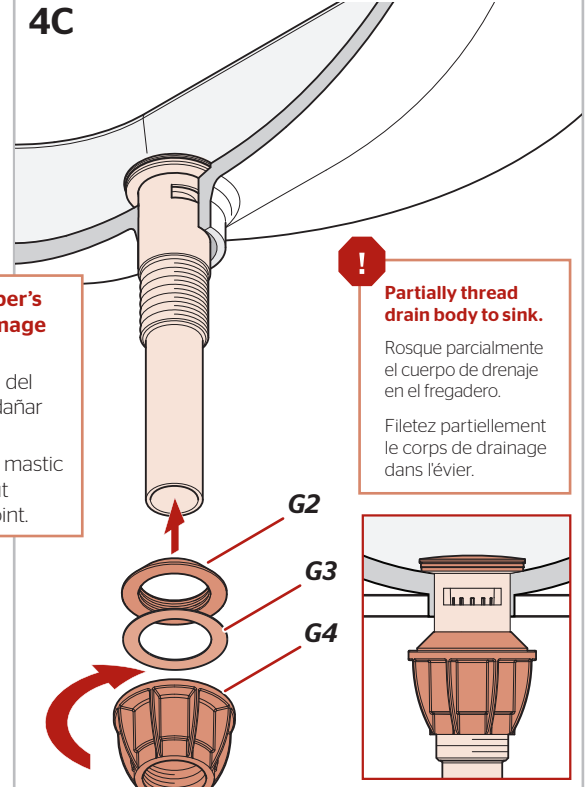

Partially thread drain body to sink.
 Rosque parcialmente el cuerpo de drenaje en el fregadero.
 Filetez partiellement le corps de drainage dans l'évier.

4D

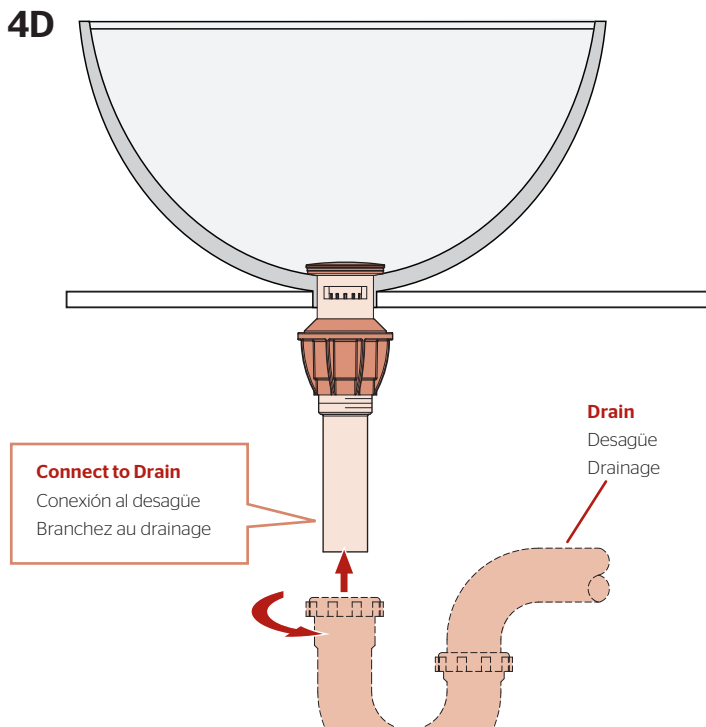

Connect to Drain
 Conexión al desagüe
 Branchez au drainage

Drain
 Desagüe
 Drainage

4E

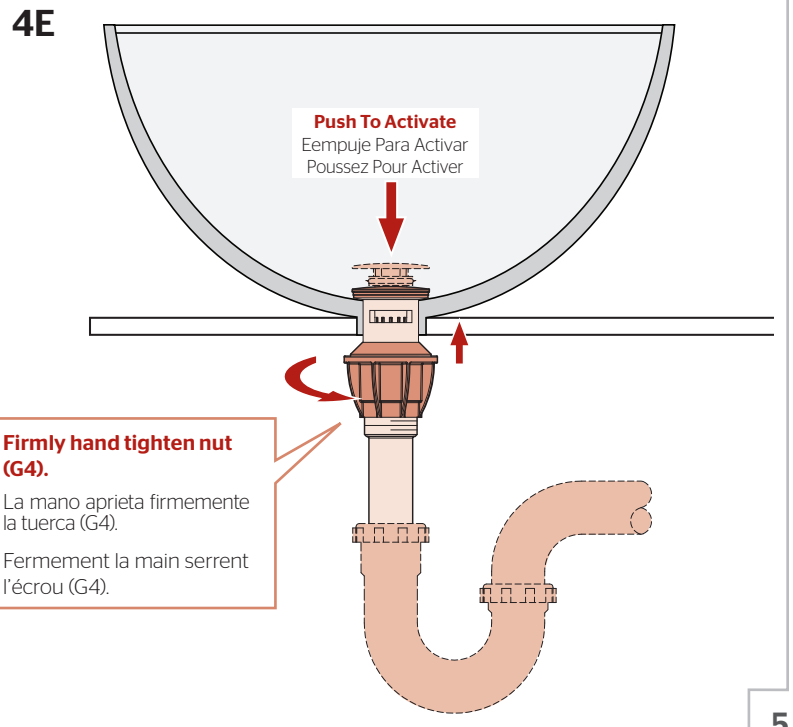

Push To Activate
 Empuje Para Activar
 Poussez Pour Activer

Firmly hand tighten nut (G4).
 La mano aprieta firmemente la tuerca (G4).
 Ferment la main serrent l'écrou (G4).

5 Remove and Set Limit Stop

Retire y Ajuste del Tope del Límite

Retirer et mettre de Stop Limit

5A

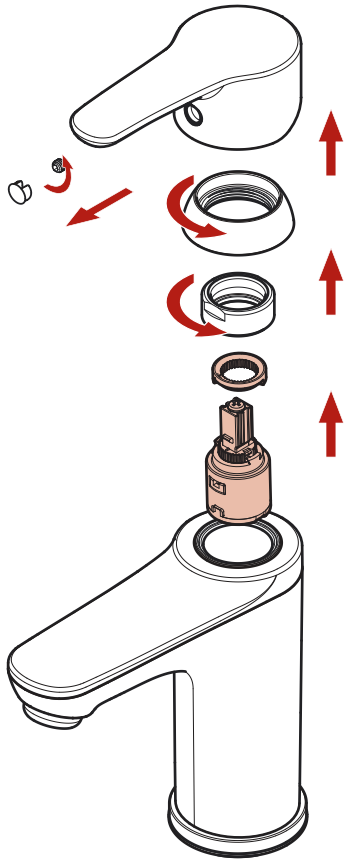

5B

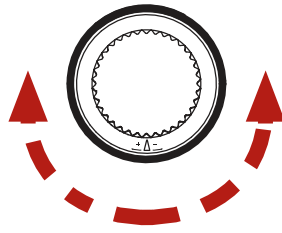

Rotate to Set to Desired Max Temperature

Gira por ajuste la Temperatura Máxima Deseada

Tournez pour régler la Température Maximale Désiré

5C

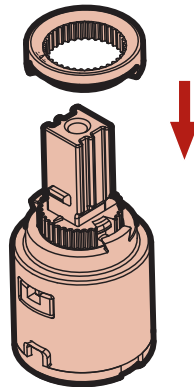

5D

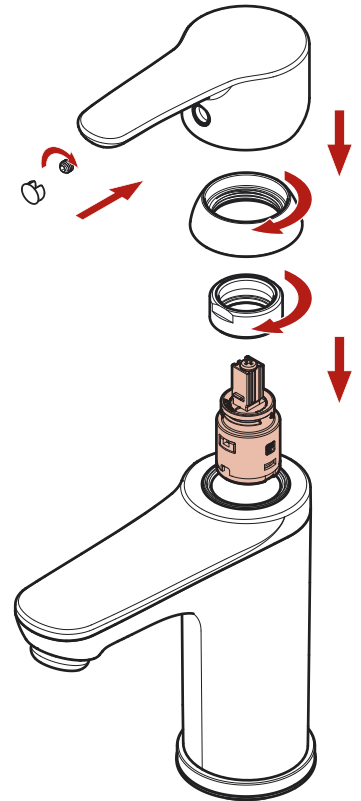

6 Turn On Water & Confirm Proper Installation

Active el suministro de agua y confirme que la instalación está adecuadamente efectuada

Ouvrez l'eau et confirmez que l'installation est correcte

6A

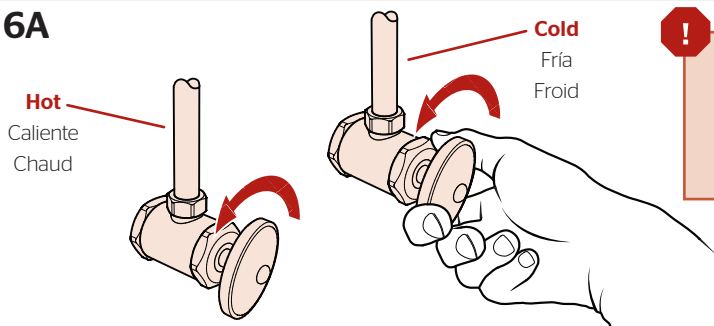

Check for leaks above and below the sink.

Revise si hay fugas encima y debajo del fregadero

Assurez-vous qu'il n'y a pas de fuite au dessus ou au dessous du lavabo.

7

Faucet Function

Funciones del grifo

Fonctionnement du robinet

7A

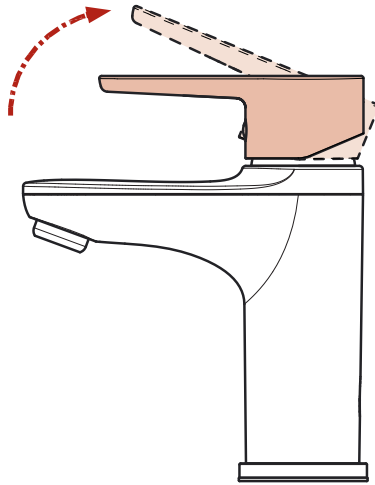

Open

Abierta
Ouvrte

Faucet Function
Funciones del grifo
Fonctionnement du robinet

Hot

Caliente
Chaud

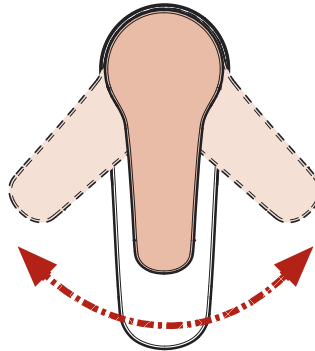

Cold

Fria
Froid

8

Flush the Faucet

Enjuague el grifo

Vidanger l'robinet

8A

Remove Aerator

Retire el aereador
Retirez l'aérateur

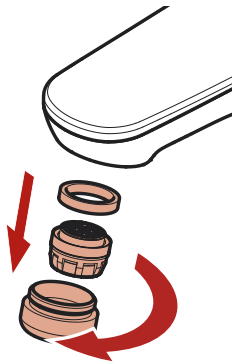

8B

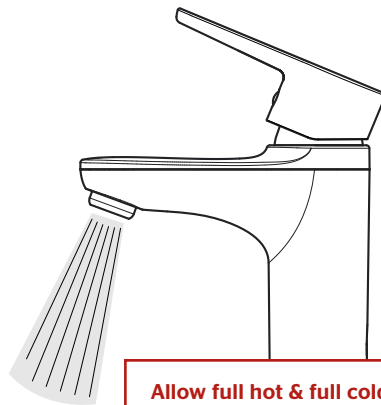

Allow full hot & full cold water to run for at least 15 seconds each.

Deje correr el agua caliente y fría durante al menos 15 segundos cada una.

Permettez à l'eau chaude et l'eau froide de couler au moins 15 secondes chacun.

8C

Reinstall Aerator

Reinstale el aereador
Réinstallez l'aérateur

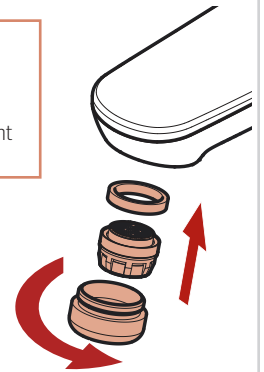

Hand Tighten

Apriete con la mano
Serrez manuellement

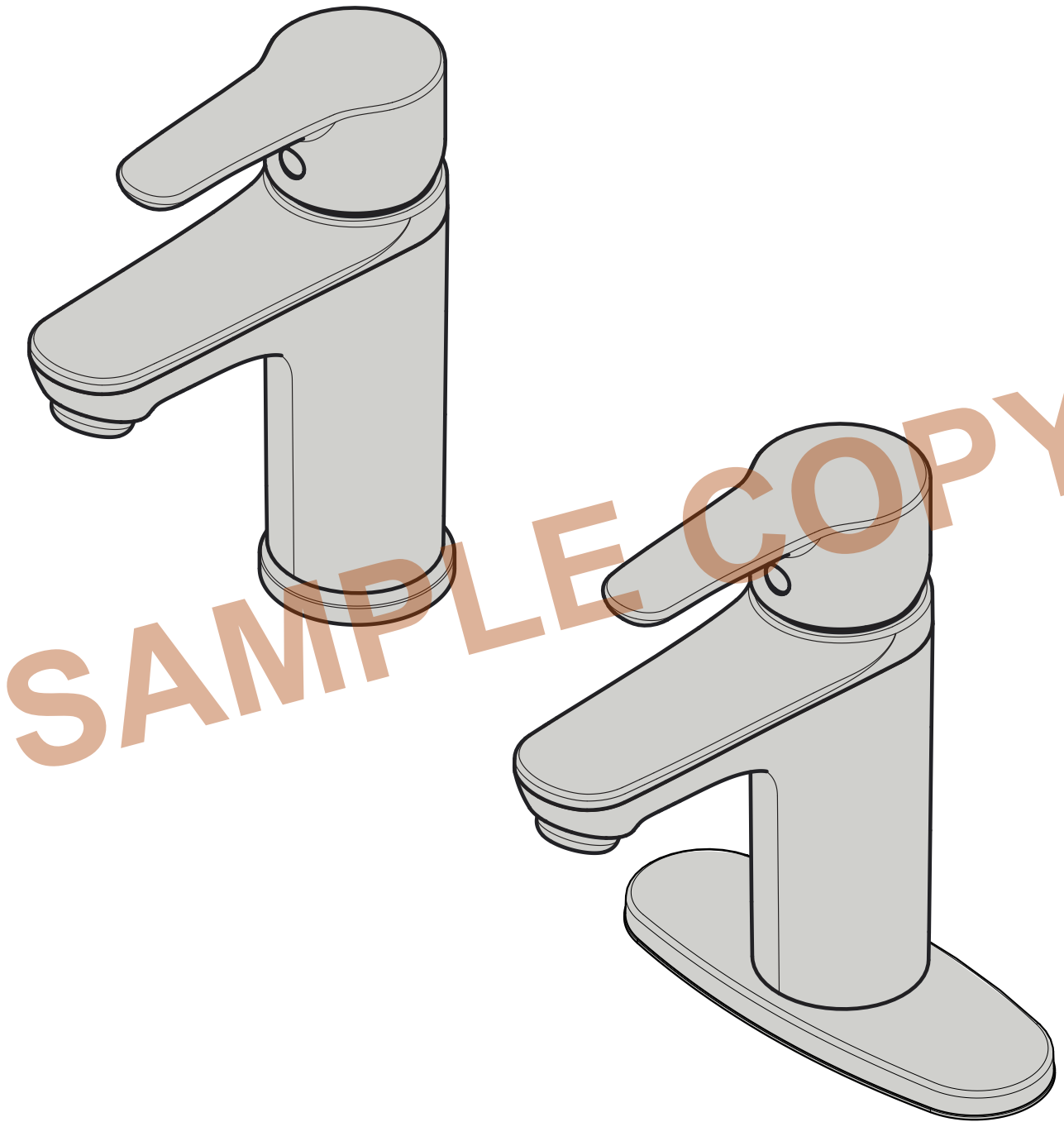

For Additional Installation Help:
Para la instalación adicionales de ayuda:
Pour les aides supplémentaires à l'installation:

Pfister[®]

1-800-PFAUCET (732-8238)
pfisterfaucets.com