

TOTO

**Installation Guide
Guide d'installations
Manual de Instalación**

NEOREST BATHTUB

ABF992X#01DCP

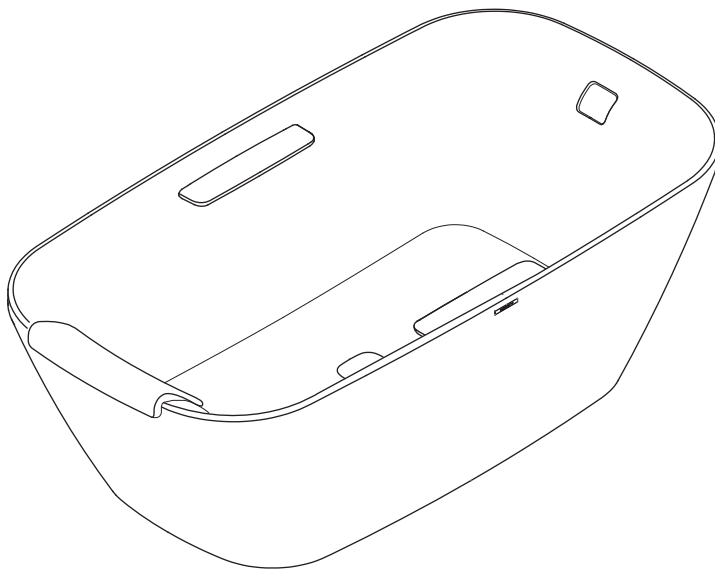



Cautions and warnings	2
Mises en garde et avertissements ...	4
Precauciones y advertencias ...	6
Included parts / Pièces fournies / Piezas incluidas	8
Specifications / Caractéristiques / Especificación	9
Dimension Drawings / Schémas des dimensions / Schemi dimensionali	10
Installation Procedure / Procédure d'installation / Procédure d'installation /	11
Building a base for the bathtub ~seating the bathtub/ Construire une base pour la baignoire ~ coinla baignoire / La construcción de una base para la bañera ~ asientos la bañera /	12
Finishing / Finition / Finilización ...	14
Pillow / Oreiller / Almohada	16

To installation contractors:		Aux prestataires d'installation:	
Please explain to the customer the functions of the BATHTUB and how to use them.		Veuillez expliquer au client les fonctions du BATHTUB et comment les utiliser.	
Para instaladores:			
Veuillez expliquer au client les fonctions du BATHTUB et comment les utiliser.			

Cautions and warnings



Before installing your BATHTUB, be sure to read the following installation instructions. Install the product only as described in this guide.

Follow all safety precautions and warnings.



 WARNING	<p>When this appears next to a topic, this indicates that misoperation could result in death or serious injury.</p>	 CAUTION	<p>When this appears next to a topic, this indicates that misoperation may result in injury or physical damage.</p>
-----------------------------------------------------------------------------------------------------	---------------------------------------------------------------------------------------------------------------------	-----------------------------------------------------------------------------------------------------	---------------------------------------------------------------------------------------------------------------------

Symbol example

	<p>The  symbol indicates something that is prohibited.</p>		<p>The  symbol indicates something that must be done.</p>
-----------------------------------------------------------------------------------	---------------------------------------------------------------------------------------------------------------------------------------------	-----------------------------------------------------------------------------------	----------------------------------------------------------------------------------------------------------------------------------------------

 WARNING	
 Prohibited	<ul style="list-style-type: none"> Do not install the tub with the rim surface as its sole support. (Doing so could cause damage.) Do not stand on bathtub while working. (Doing so could cause one to slip and fall or could otherwise damage the product.) Only assemble the parts delivered or indicated. Do not change these parts. (In particular, do not change the dimensions.)
 Required	<ul style="list-style-type: none"> Install securely, in accordance with the Installation Guide. (It could cause water leaks that damage or ruin household property.) Install the drainage pipes securely, in accordance with the procedure. (Improper installation could lead to leaks that damage or ruin household property.) After unpacking, immediately dispose of unwanted packaging materials. (There is a risk of injury from the wooden frame, nails, cardboard boxes, vinyl bags or sealing straps. Additionally, ensure that children do not play with the packaging materials as this could lead to suffocation or other accidents.) Install the bathtub securely in a stable location that can bear the weight of the bathtub in accordance with the Installation Guide. Ensure that you have an ergonomic working position during transport and assembly. (Take care at every stage that your move is safe. Ensure that you have assistance to avoid risk of accident or injury.) Check local laws and codes for any specific instructions on installation and/or use not covered in this manual.



 **CAUTION**

 Prohibited	<ul style="list-style-type: none"> Do not place anything heavy on the tub or anything in the tub for standing on. (Doing so could cause damage.)
	<ul style="list-style-type: none"> Do not drop any heavy or hard objects in the bathtub. (Injury may result from cracks in the bathtub or leaking water may contaminate or ruin household property.)
	<ul style="list-style-type: none"> Keep sources of heat at a distance. Do not smoke. (Otherwise there is a risk of damage.)
	<ul style="list-style-type: none"> Do not install the bathtub outdoors or in a location where it will be constantly exposed to sunlight (for example, in a sunroom). (Otherwise there is a risk of frost damage or discoloration.)
	<ul style="list-style-type: none"> When transporting the bathtub, do not carry by the hoses or plumbing or strike it with anything hard.
 Required	<ul style="list-style-type: none"> Before installing the bathtub, check the bathtub and pipes for damage or abnormality. (Do not assemble any damaged or abnormal components. Obtain replacement parts.)
	<ul style="list-style-type: none"> Do not remove the protective sheet on the bathtub until installation is complete.
	<ul style="list-style-type: none"> Ensure the bathtub can be used and maintained adequately.
	<ul style="list-style-type: none"> Check for leaks after installation is complete. (Shut off the water supply if you discover any leaks and immediately repair them.)

Mises en garde et avertissements



Avant d'installer votre BATHTUB, assurez-vous de lire les instructions d'installation suivantes. Installez ce produit en suivant exclusivement la procédure décrite dans ce guide.

Suivez toutes les précautions et les avertissements de sécurité.

 AVERTISSEMENT	Lorsque ce symbole apparaît en regard d'une rubrique, cela indique que toute utilisation incorrecte pourrait entraîner la mort ou une blessure grave.	 MISE EN GARDE	Lorsque ce symbole apparaît en regard d'une rubrique, cela indique que toute utilisation incorrecte peut entraîner une blessure ou un dommage physique.
-----------------------------------------------------------------------------------------------------------	-------------------------------------------------------------------------------------------------------------------------------------------------------	-----------------------------------------------------------------------------------------------------------	---------------------------------------------------------------------------------------------------------------------------------------------------------

Exemple de symbole

	Le symbole  indique que quelque chose est interdit.		Le symbole  indique que quelque chose doit être fait.
-----------------------------------------------------------------------------------	--------------------------------------------------------------------------------------------------------------------------------------	-----------------------------------------------------------------------------------	------------------------------------------------------------------------------------------------------------------------------------------

 AVERTISSEMENT	
 Interdit	<ul style="list-style-type: none"> • N'installez pas la baignoire avec la surface périphérique comme unique support. (Cela pourrait provoquer des dégâts.) • Ne montez pas sur la baignoire pendant que vous travaillez. (Vous risqueriez de glisser et de tomber ou d'endommager le produit.) • Assemblez exclusivement les pièces fournies ou indiquées. Ne modifiez pas ces pièces. (En particulier, ne modifiez pas les dimensions.)
 Requis	<ul style="list-style-type: none"> • Installez convenablement, conformément au Guide d'installation. (Sinon, cela pourrait entraîner des fuites susceptibles de provoquer des dégâts matériels éventuellement irréversibles.) • Installez convenablement les tuyaux de vidange, conformément à la procédure. (Une installation incorrecte pourrait entraîner des fuites susceptibles de provoquer des dégâts matériels éventuellement irréversibles.) • Après le déballage, veuillez immédiatement mettre au rebut les emballages inutiles. (Vous risqueriez de vous blesser avec les cadres en bois, clous, boîtes en carton, sacs en vinyle ou sangles de scellage. Par ailleurs, veillez à ce que les enfants ne jouent pas avec les emballages, car ils risqueraient de s'étouffer ou de provoquer d'autres accidents.) • Installez convenablement la baignoire dans un endroit stable pouvant supporter son poids conformément au Guide d'installation. • Pendant le transport et l'assemblage, adoptez une position de travail ergonomique. (A chaque étape, soyez attentif à ce que vos mouvements s'effectuent en toute sécurité. Veillez à vous faire aider pour éviter tout risque d'accident ou de blessure.) • Vérifiez les lois et les codes locaux pour les instructions spécifiques d'installation et/ou d'utilisation non couvertes dans ce manuel.





MISE EN GARDE

 Interdit	<ul style="list-style-type: none"> • Ne placez rien de lourd sur la baignoire et ne placez rien dans la baignoire afin de monter dessus. (Cela pourrait provoquer des dégâts.)
	<ul style="list-style-type: none"> • Ne laissez pas tomber d'objets lourds ou durs dans la baignoire. (Les fissures dans la baignoire risqueraient de vous blesser et une fuite pourrait souiller vos biens ou les endommager de manière irréversible.)
	<ul style="list-style-type: none"> • Eloignez toute source de chaleur. Ne fumez pas. (Vous risqueriez de provoquer des dégâts.)
	<ul style="list-style-type: none"> • N'installez pas la baignoire à l'extérieur ou dans un endroit où elle sera exposée en permanence aux rayons du soleil (par exemple, dans une véranda). (Cela risquerait de provoquer des dégâts dus au gel ou une décoloration.)
	<ul style="list-style-type: none"> • Lors du transport de la baignoire, ne la portez pas par les tuyaux ou la tuyauterie et ne la heurtez pas avec un objet dur.
 Requis	<ul style="list-style-type: none"> • Avant d'installer la baignoire, vérifiez-la ainsi que la tuyauterie, à la recherche d'éventuels dégâts ou anomalies. (N'assemblez pas de composants endommagés ou anormaux. Procurez-vous des pièces de rechange.)
	<ul style="list-style-type: none"> • Ne retirez la feuille protectrice de la baignoire qu'une fois l'installation terminée.
	<ul style="list-style-type: none"> • Vérifiez que la baignoire peut être correctement utilisée et entretenue.
	<ul style="list-style-type: none"> • Une fois l'installation terminée, recherchez les fuites éventuelles. (Si vous détectez une fuite, coupez l'alimentation en eau et réparez-la immédiatement.)



Precauciones y advertencias

Antes de instalar su bañera, asegúrese de leer las siguientes instrucciones de instalación. Instale el producto tal como se describe en esta guía. Siga todas las precauciones y advertencias de seguridad.



 Precaución	Cuando esto aparezca junto a un tema, significa que la operación incorrecta podría provocar la muerte o lesiones graves.	 Estar atento	Cuando esto aparezca junto a un tema, significa que la operación incorrecta podría provocar lesiones físicas.
--------------------------------------------------------------------------------------------------------	--------------------------------------------------------------------------------------------------------------------------	----------------------------------------------------------------------------------------------------------	---------------------------------------------------------------------------------------------------------------

Símbolos ejemplares

	Este  símbolo indica las cosas prohibidas.		Este  símbolo indica las cosas requeridas.
-----------------------------------------------------------------------------------	-----------------------------------------------------------------------------------------------------------------------------	-----------------------------------------------------------------------------------	-------------------------------------------------------------------------------------------------------------------------------

 PRECAUSION	
 Prohibido	<ul style="list-style-type: none"> No instale la bañera con la superficie de reborde como su único apoyo. (Si lo hace, podría ocasionar daños.)
	<ul style="list-style-type: none"> No se pise en la bañera mientras trabaja. (Si lo hace, podría causar resbalones y caídas o de lo contrario podría dañar el producto.)
	<ul style="list-style-type: none"> Sólo monte piezas entregadas o indicadas. No cambie estas piezas. (En particular, no cambie las dimensiones.)
 Obligatorio	<ul style="list-style-type: none"> Instale de forma segura, de acuerdo con el Manual de Instalación. (Podría causar fugas de agua que pueda dañar o arruinar la propiedad de los hogares.)
	<ul style="list-style-type: none"> Instale las tuberías de desagüe de forma segura, de acuerdo con el procedimiento. (La instalación incorrecta podría provocar fugas de agua que pueda dañar o arruinar la propiedad de los hogares)
	<ul style="list-style-type: none"> Después de abrir el embalaje, hay que alejarse de los materiales de embalaje no deseados. (Hay el riesgo de lesiones causadas por el marco de madera, clavos, cajas de cartón, bolsas de vinilo o cintas de sellado. Además, asegúrese de que los niños no jueguen con el material de embalaje, ya que esto podría causar a la asfixia u otros accidentes.)
	<ul style="list-style-type: none"> Instale la bañera de forma segura en un lugar estable que pueda soportar el peso de la bañera de acuerdo con el Manual de Instalación.
	<ul style="list-style-type: none"> Asegúrese de la posición adecuado de trabajo durante el transporte y el montaje. (Tenga cuidado en todo el tiempo que su movimiento es seguro. Asegúrese de la asistencia para evitar el riesgo de accidentes o lesiones.)
	<ul style="list-style-type: none"> Revise las leyes y códigos locales para conocer cualquier instrucción específica acerca de la instalación y/o uso no cubierta en este manual.

 **ADVERTENCIA**

 Prohibido	<ul style="list-style-type: none"> • No deje objetos pesados sobre la bañera ni cosas para pisar por encima. (Si lo hace, podría ocasionar daños.)
	<ul style="list-style-type: none"> • No deje caer objetos pesados o duros en la bañera. (Podría causar grietas en la bañera o fuga de agua que pueda contaminar o dañar la propiedad del hogar.)
	<ul style="list-style-type: none"> • Mantenga las fuentes de calor a distancia. No fume. (De lo contrario se corre el riesgo de daño.)
	<ul style="list-style-type: none"> • No instale la bañera al aire libre o en un lugar donde quede expuesto constantemente a la luz solar. (Por ejemplo, en una habitación solar). (De lo contrario, existe el riesgo de daños por congelación o decoloración.)
	<ul style="list-style-type: none"> • Cuando transporte la bañera, no lleve junto con las mangueras o tuberías ni la golpee con objetos duros.
 Obligatorio	<ul style="list-style-type: none"> • Antes de instalar la bañera, revise la bañera y tuberías si hay daño o anomalía. (No monte los componentes dañados o anormales. Obtenga piezas de repuesto.)
	<ul style="list-style-type: none"> • No retire la hoja protectora en la bañera hasta que se complete la instalación.
	<ul style="list-style-type: none"> • Asegúrese de que la bañera ha sido utilizada y mantenida adecuadamente.
	<ul style="list-style-type: none"> • Compruebe si hay fugas después de la instalación. (Cierre el suministro de agua si se descubre alguna fuga y solucione la falla de inmediato).

Included parts / Pièces fournies / Piezas incluidas

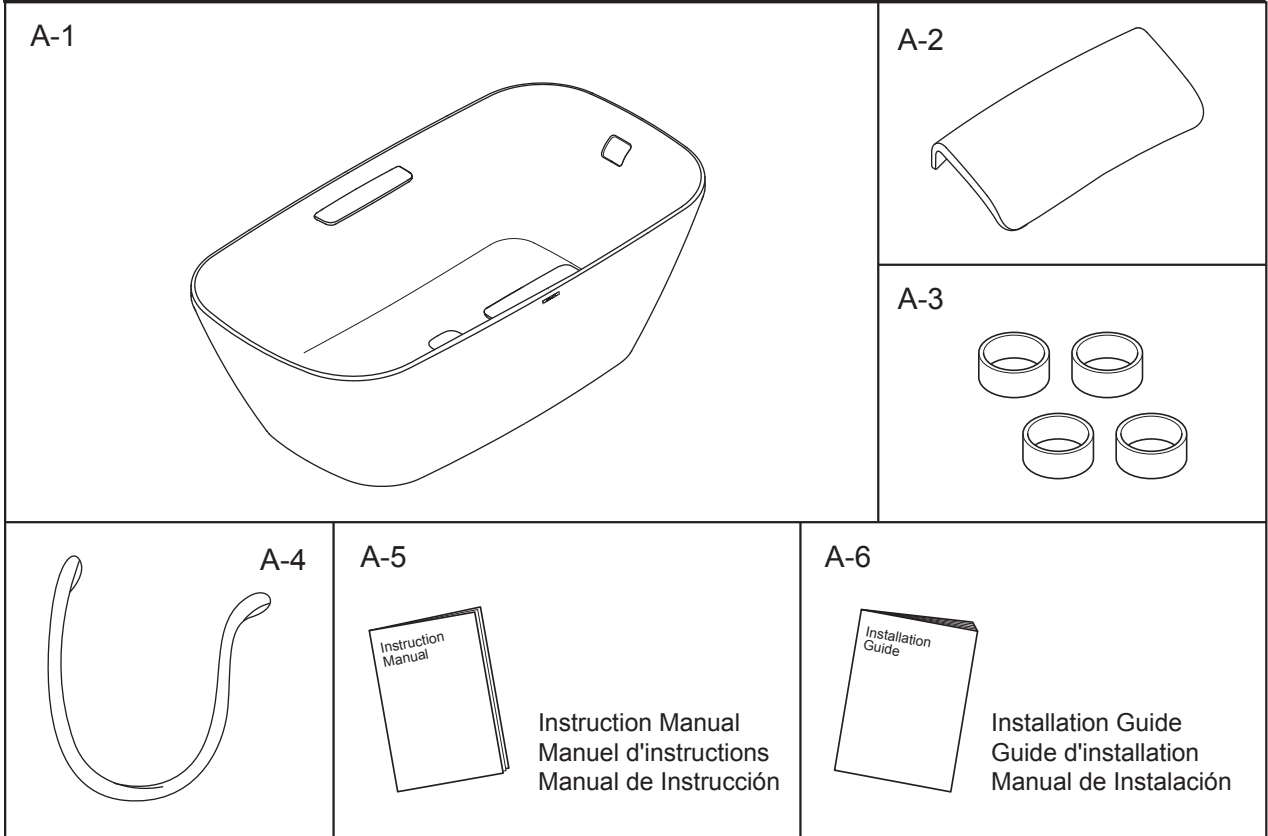

Required tools/ Outils requis / Utensili richiesti

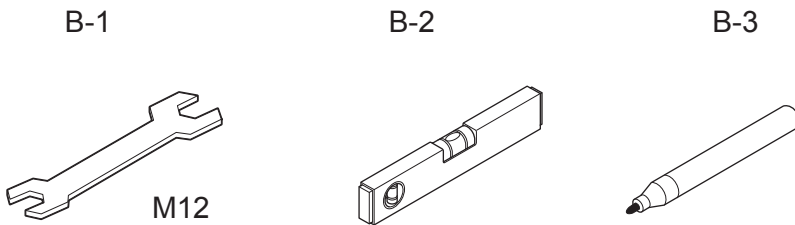

Specifications / Caractéristiques / Especificación

GB

Specification	ABF992X#01DCP
Dimension	70-7/8" x 37-3/8" x 23-5/8" (1800 mm x 950 mm x 600 mm)
Weight	295 lbs (134 kg)
Capacity	81 gallons (306 L) to overflow line
Drainage fittings	Special pedal type
Installation mode	Independent type
Material	FRP, artificial marble etc.
Color	Cotton (#01)

FR

Especificaciones	ABF992X#01DCP
Dimensión	70-7/8" x 37-3/8" x 23-5/8" (1800 mm x 950 mm x 600 mm)
Peso	295 lbs (134 kg)
Capacidad	81 galones (306L) a desbordarse línea
Drainage fittings	Pedal especial
Modo de instalación	Tipo Independente
Material	FRP, mármol artificial
Color	Cotton (#01)

ES

Spécification	ABF992X#01DCP
Dimension	70-7/8" x 37-3/8" x 23-5/8" (1800 mm x 950 mm x 600 mm)
Poids	295 lbs (134 kg)
Capacité	81 gallons (306L) to antidébordement
Raccords de drainage	Pédale spéciale
Mode d'installation	Independent type
Matériel	FRP, Marbre artificiel
Couleur	Cotton (#01)

Dimension Drawings / Schémas des dimensions / Schemi dimensionali

- Bathtub
- Baignoire
- Bañera

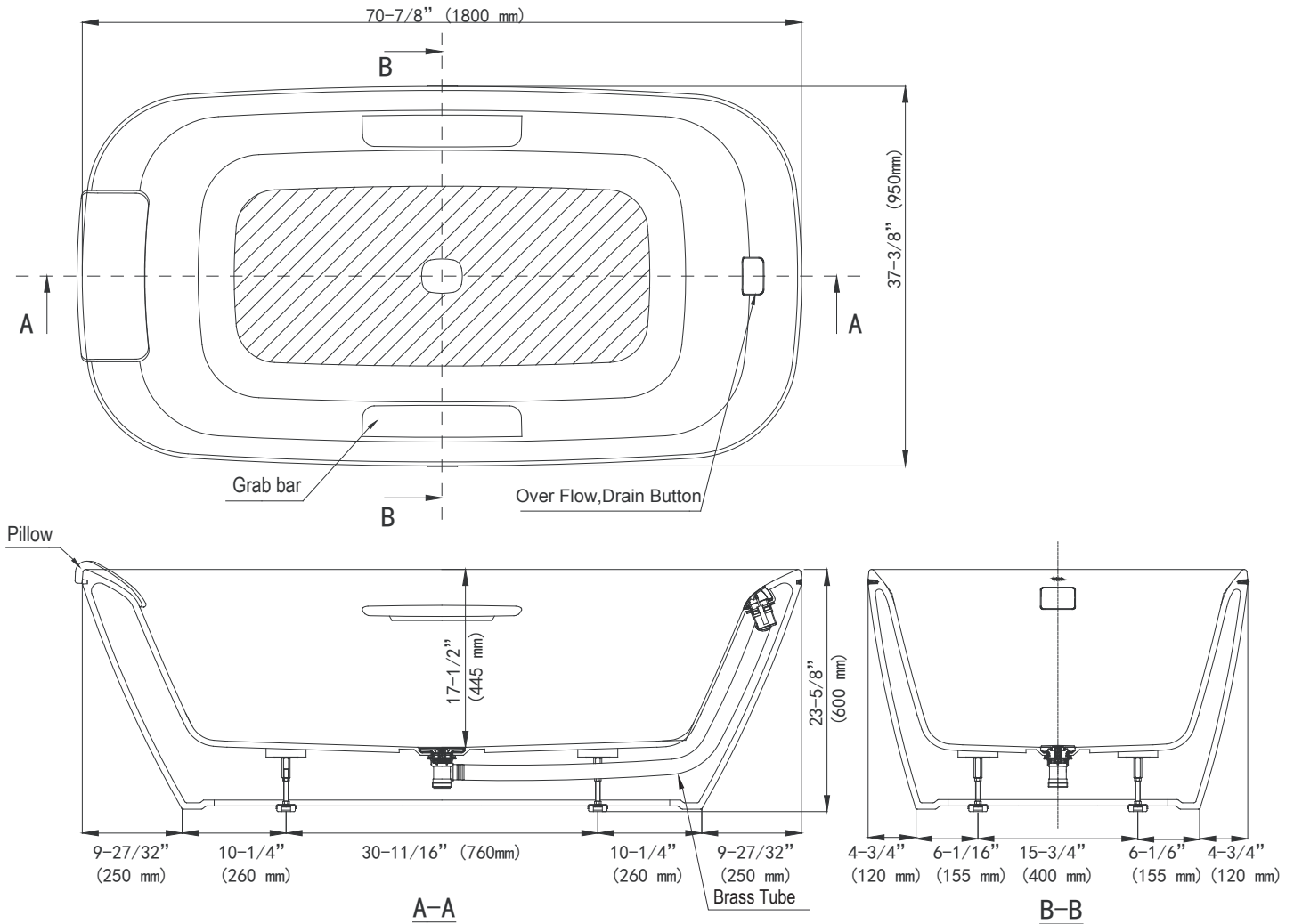

Spec Notes: The diameter of the bathtub outlet tailpiece is 1-1/2" (38 mm) brass.

Remarques Spec: Le diamètre de la queue de sortie de la baignoire est de 1-1/2 (38 mm) en laiton.

Spec Notas: El diámetro del tubo de desagüe de salida bañera es de 1-1/2 "(38 mm) de latón.

Installation Procedure
Procédure d'installation
Proceso de Instalación

Building a base for the bathtub
~ seating the bathtub
Fabrication d'une base pour la baignoire
~ installation de la baignoire
Construir la base de bañera
~ Instalación de la bañera

- ▶ See page 12.
- ▶ Voir page 12.
- ▶ Ver la página 12.



Finishing
Finition
Finalización

- ▶ See page 14.
- ▶ Voir page 14.
- ▶ Ver página 14.



Pillow
Oreiller
Almohada

- ▶ See page 16.
- ▶ Voir page 16.
- ▶ Ver página 16.

Meaning of the indications
Signification des indications
Significado de indicaciones

GB

 : Task that must be conducted by the installer

 : Action that the BATHTUB should perform automatically

 : Work that requires confirmation

 : Shows the work sequence

FR

 : Tâche incombant à l'installateur

 : Action que le BATHTUB doit exécuter automatiquement

 : Tâche exigeant une vérification

 : Indique l'ordre de suivi de la procédure

ES

 : Tarea que debe llevarse a cabo por el instalador

 : Funcionamiento de la bañera debe realizar automáticamente

 : El trabajo requiere confirmación

 : Muestra la secuencia de trabajo

Building a base for the bathtub ~ seating the bathtub
Fabrication d'une base pour la baignoire ~ installation de la baignoire
Construir la base de bañera ~ instalar la bañera

1

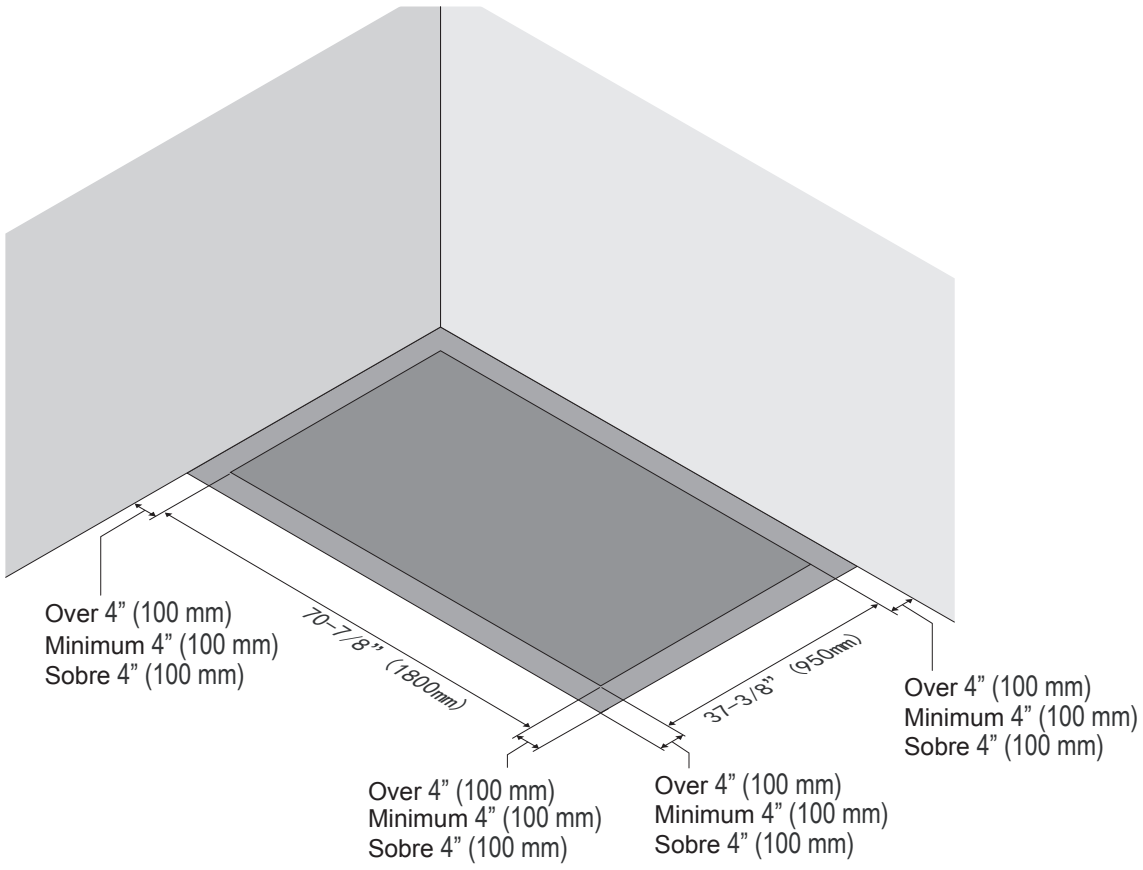

2

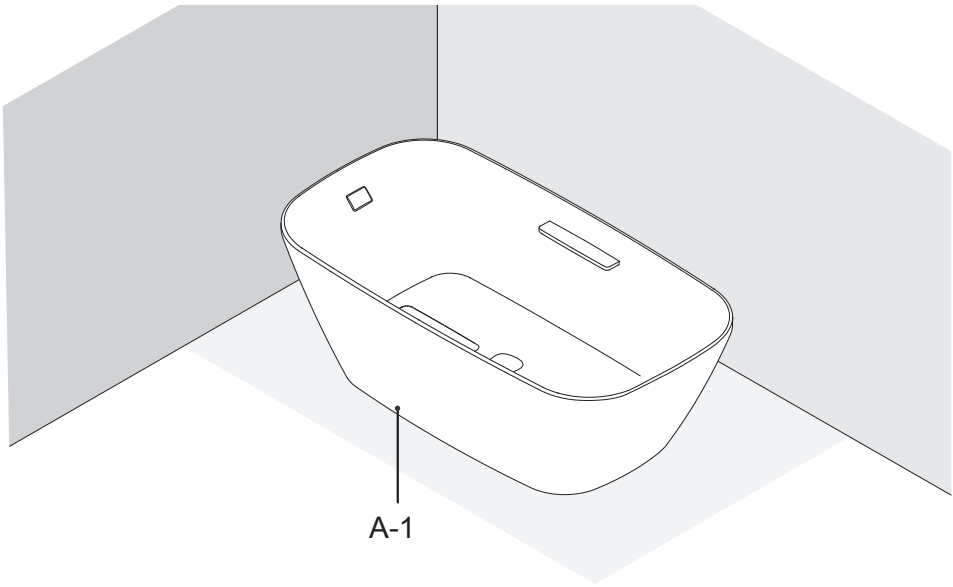

3

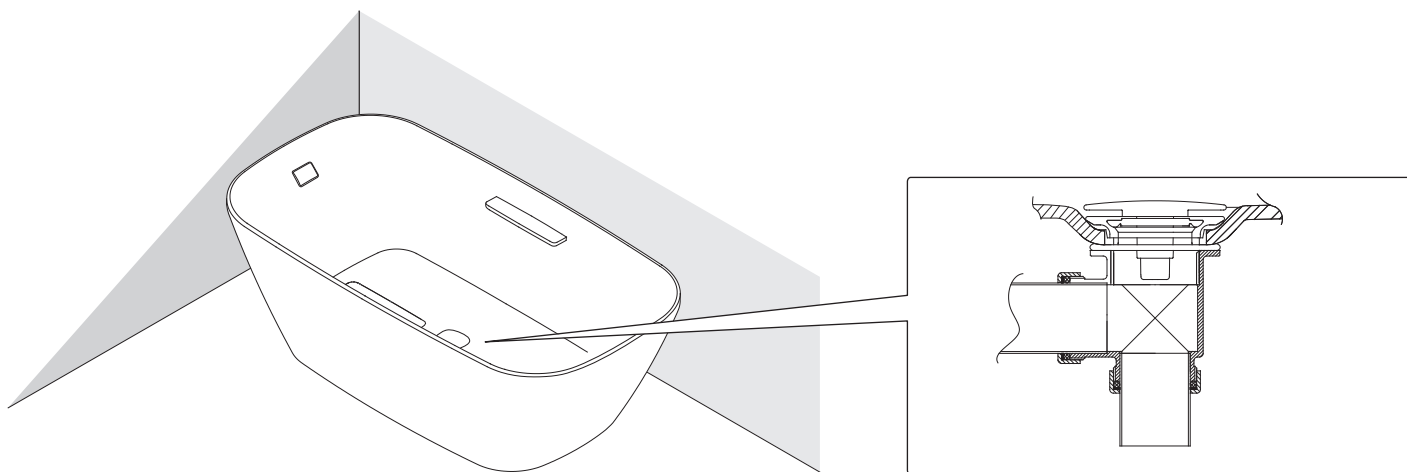

4

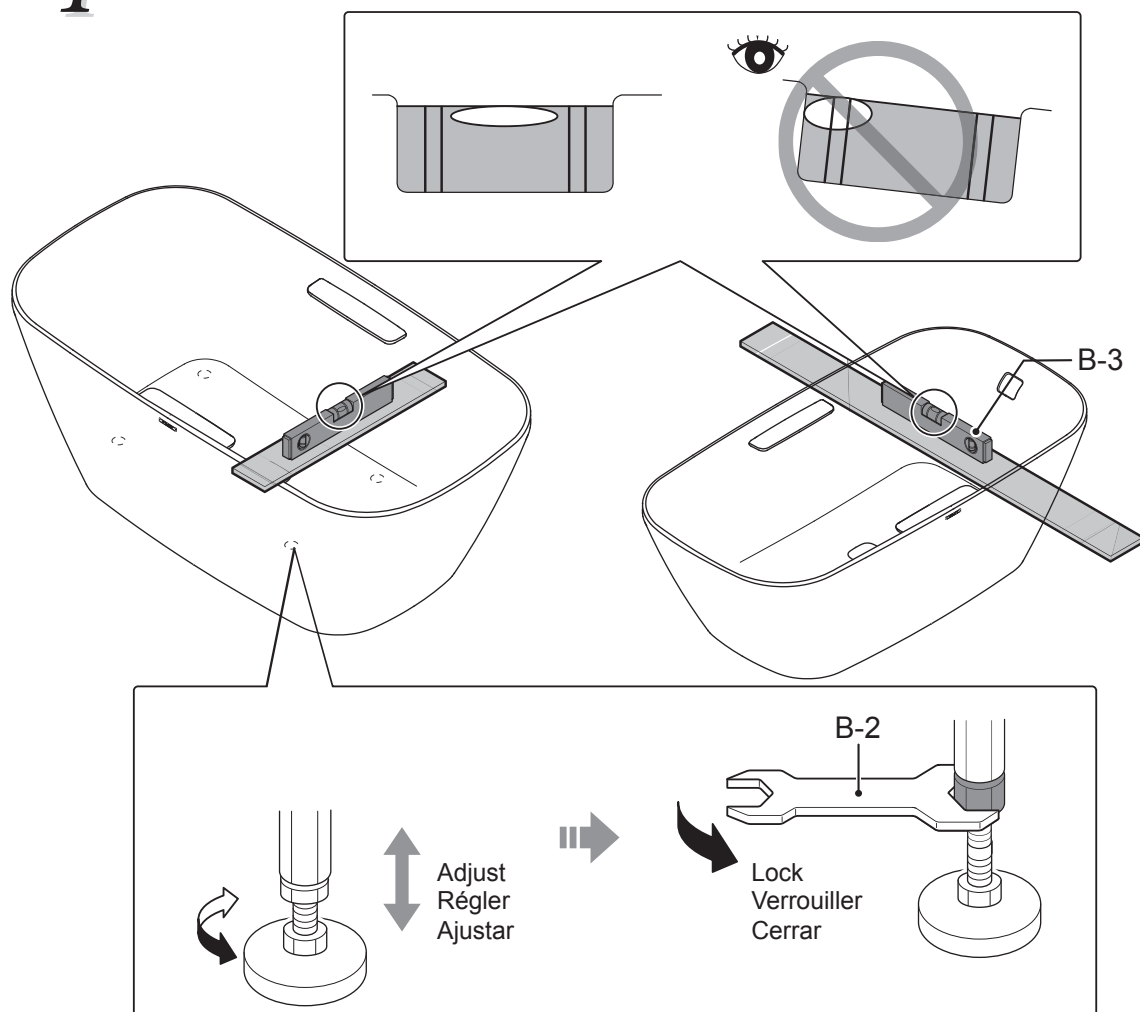

Finishing / Finition / Finilización

1

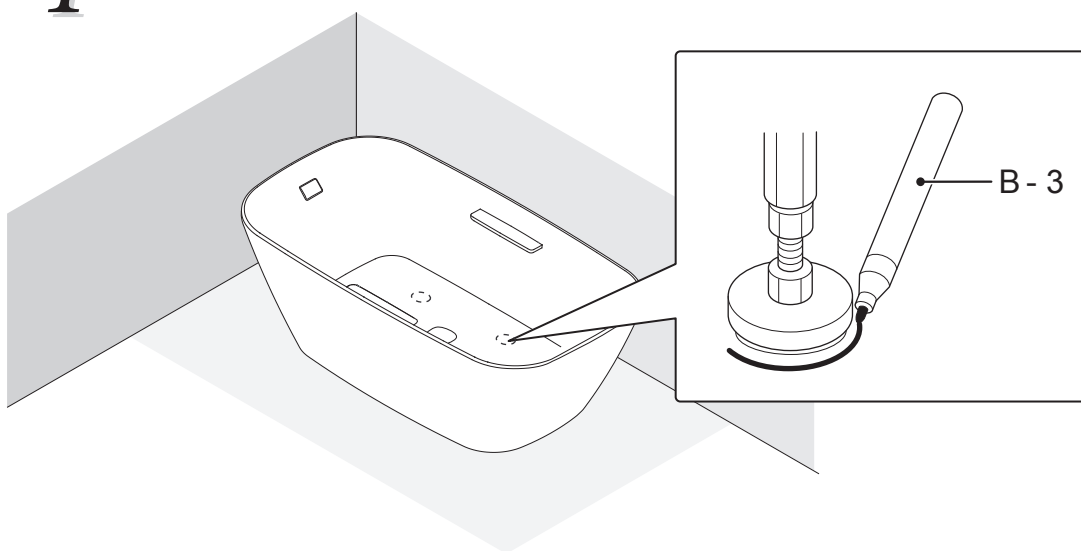

2

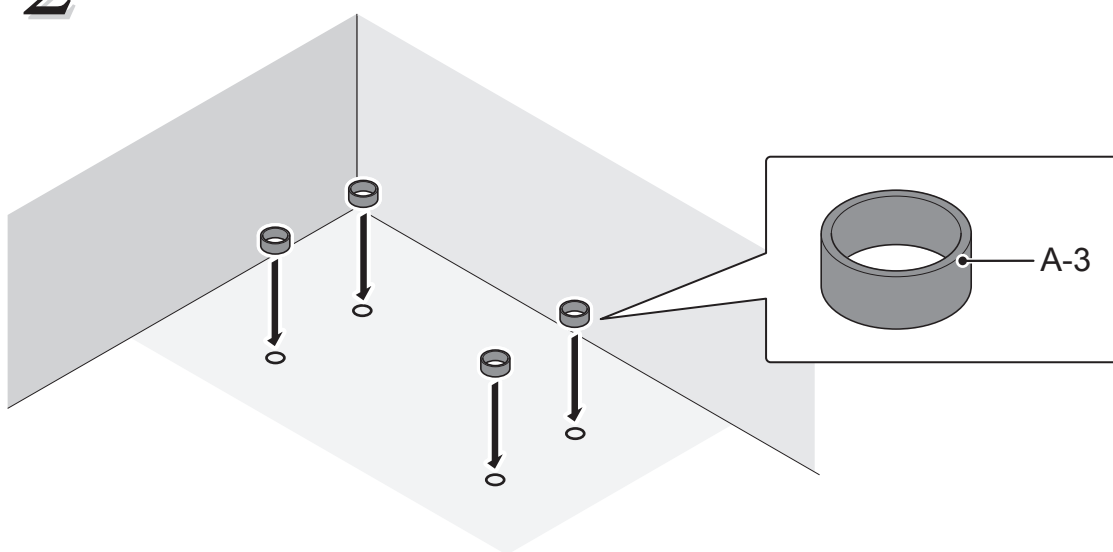

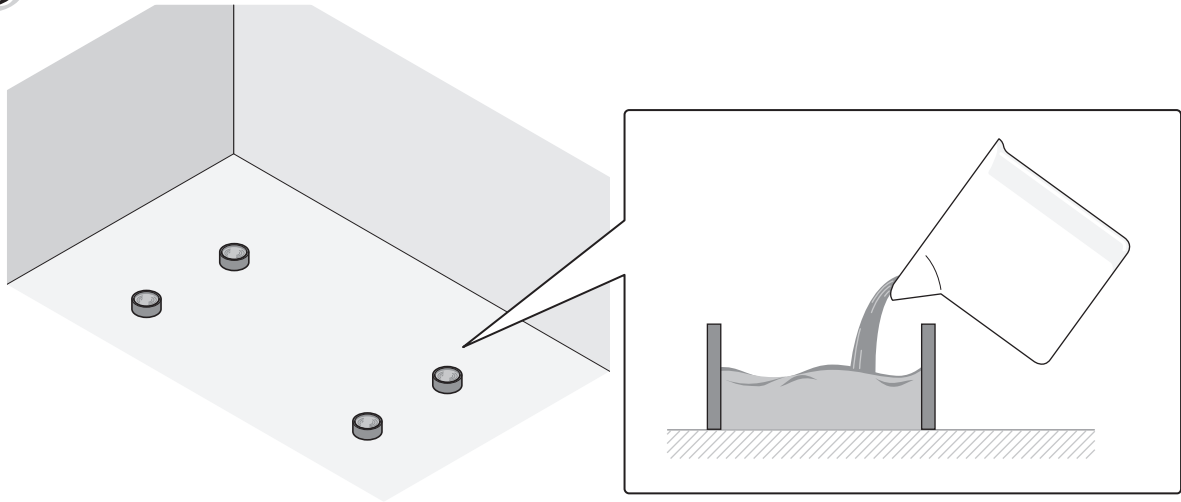

3



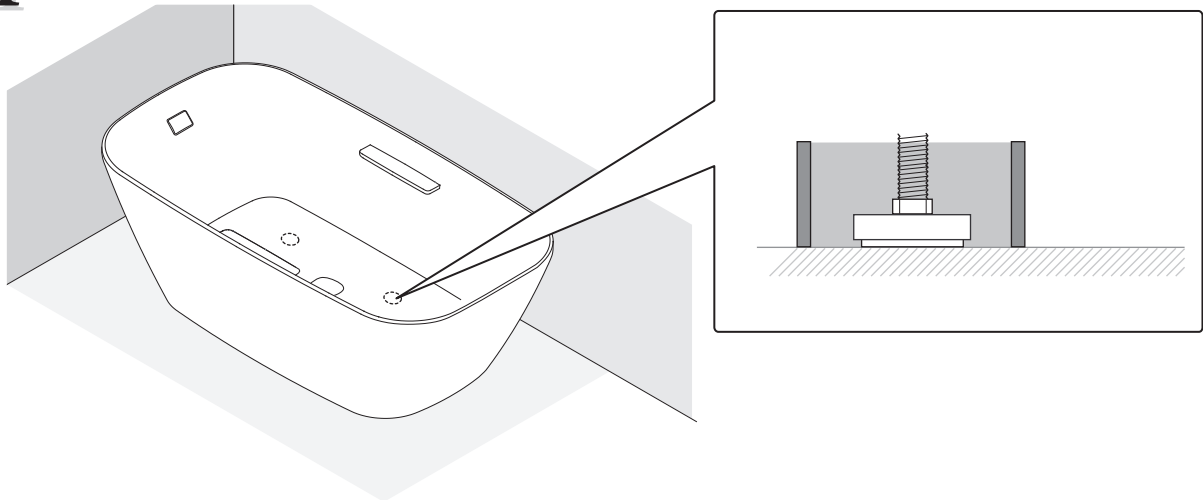



4

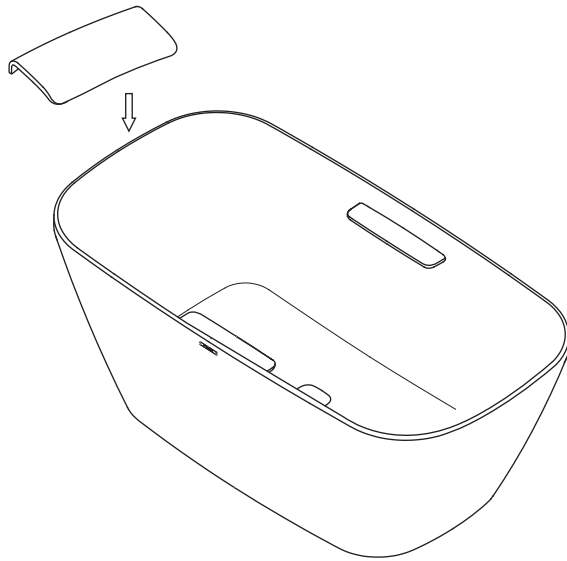

[GB] CAUTION	
 Required	Fix the bathtub in place with mortar according to the provided parts (A-3).
[FR] MISE EN GARDE	
 Requis	Fixez la baignoire avec du mortier en utilisant les pièces fournies (A-3).
[ES] ADVERTENCIA	
 Requerido	Fije la bañera en su lugar con mortero de acuerdo a las piezas proporcionadas (A-3)

Pillow / Oreiller / Almohada



[GB] CAUTION	
 Required	Pillow must be mounted on the opposite side of the drain button.(A-2)
[FR] MISE EN GARDE	
 Requis	Oreiller doit être monté sur le côté opposé de la touche de vidange.(A-2)
[SE] PRECAUCIÓN	
 Obligatorio	Almohada debe ser montado en el lado opuesto del botón de drenaje. (A-2)

© TOTO Ltd.All rights reserved.
 ©TOTO Ltd. Tous droits réservés.
 ©TOTO Ltd.Reservados todos los derechos.

Printed in China.
 Imprimé au China.
 Impreso en China.